

CONFIDENTIAL

SAMSUNG

TFT-LCD TV/MONITOR

Chassis	Model
MB15U*	LTM1525
MB15J*	LT15S13C

SERVICE Manual

TFT-LCD TV/MONITOR

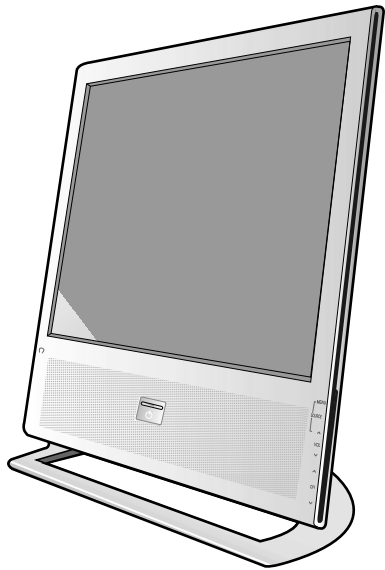

CONTENTS

1. Precautions
2. Product Specifications
3. Disassembly & Reassembly
4. Alignment & Adjustments
5. Troubleshooting
6. Exploded View & Parts List
7. Electrical Parts List
8. Block Diagram
9. Wiring Diagram
10. Schematic Diagrams
11. Panel Description

1 Precautions

Follow these safety, servicing and ESD precautions to prevent damage and to protect against potential hazards such as electrical shock.

1-1 Safety Precautions

1-1-1 Warnings

1. For continued safety, do not attempt to modify the circuit board.
2. Disconnect the AC power and DC Power Jack before servicing.

1-1-2 Servicing the LCD Monitor

1. When servicing the LCD Monitor Disconnect the AC line cord from the AC outlet.
2. It is essential that service technicians have an accurate voltage meter available at all times. Check the calibration of this meter periodically.

1-1-3 Fire and Shock Hazard

Before returning the monitor to the user, perform the following safety checks:

1. Inspect each lead dress to make certain that the leads are not pinched or that hardware is not lodged between the chassis and other metal parts in the monitor.
2. Inspect all protective devices such as nonmetallic control knobs, insulating materials, cabinet backs, adjustment and compartment covers or shields, isolation resistor-capacitor networks, mechanical insulators, etc.
3. Leakage Current Hot Check (Figure 1-1):
WARNING: Do not use an isolation transformer during this test.

Use a leakage current tester or a metering system that complies with American National Standards Institute (*ANSI C101.1, Leakage Current for Appliances*), and Underwriters Laboratories (*UL Publication UL1410, 59.7*).

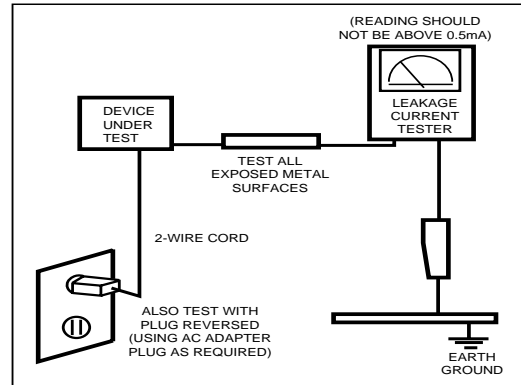



Figure 1-1. Leakage Current Test Circuit

4. With the unit completely reassembled, plug the AC line cord directly into a 120V AC outlet. With the unit's AC switch first in the ON position and then OFF, measure the current between a known earth ground (metal water pipe, conduit, etc.) and all exposed metal parts, including: metal cabinets, screwheads and control shafts. The current measured should not exceed 0.5 milliamp. Reverse the power-plug prongs in the AC outlet and repeat the test.

1-1-4 Product Safety Notices

Some electrical and mechanical parts have special safety-related characteristics which are often not evident from visual inspection. The protection they give may not be obtained by replacing them with components rated for higher voltage, wattage, etc. Parts that have special safety characteristics are identified by  on schematics and parts lists. A substitute replacement that does not have the same safety characteristics as the recommended replacement part might create shock, fire and / or other hazards. Product safety is under review continuously and new instructions are issued whenever appropriate.

1-2 Servicing Precautions

WARNING: An electrolytic capacitor installed with the wrong polarity might explode.

Caution: Before servicing units covered by this service manual, read and follow the Safety Precautions section of this manual.

Note: If unforeseen circumstances create conflict between the following servicing precautions and any of the safety precautions, always follow the safety precautions.

1-2-1 General Servicing Precautions

1. Always unplug the unit's AC power cord from the AC power source and disconnect the DC Power Jack before attempting to:
 - (a) remove or reinstall any component or assembly,
 - (b) disconnect PCB plugs or connectors, (c) connect a test component in parallel with an electrolytic capacitor.
2. Some components are raised above the printed circuit board for safety. An insulation tube or tape is sometimes used. The internal wiring is sometimes clamped to prevent contact with thermally hot components. Reinstall all such elements to their original position.
3. After servicing, always check that the screws, components and wiring have been correctly reinstalled. Make sure that the area around the serviced part has not been damaged.
4. Check the insulation between the blades of the AC plug and accessible conductive parts (examples: metal panels, input terminals and earphone jacks).
5. Insulation Checking Procedure: Disconnect the power cord from the AC source and turn the power switch ON. Connect an insulation resistance meter (500 V) to the blades of the AC plug.
The insulation resistance between each blade of the AC plug and accessible conductive parts (see above) should be greater than 1 megohm.
6. Always connect a test instrument's ground lead to the instrument chassis ground before connecting the positive lead; always remove the instrument's ground lead last.

1-3 Electrostatically Sensitive Devices (ESD) Precautions

Some semiconductor (solid state) devices can be easily damaged by static electricity. Such components are commonly called Electrostatically Sensitive Devices (ESD). Examples of typical ESD devices are integrated circuits and some field-effect transistors. The following techniques will reduce the incidence of component damage caused by static electricity.

1. Immediately before handling any semiconductor components or assemblies, drain the electrostatic charge from your body by touching a known earth ground. Alternatively, wear a discharging wrist-strap device. To avoid a shock hazard, be sure to remove the wrist strap before applying power to the monitor.
2. After removing an ESD-equipped assembly, place it on a conductive surface such as aluminum foil to prevent accumulation of an electrostatic charge.
3. Do not use freon-propelled chemicals. These can generate electrical charges sufficient to damage ESDs.
4. Use only a grounded-tip soldering iron to solder or desolder ESDs.
5. Use only an anti-static solder removal device. Some solder removal devices not classified as "anti-static" can generate electrical charges sufficient to damage ESDs.
6. Do not remove a replacement ESD from its protective package until you are ready to install it. Most replacement ESDs are packaged with leads that are electrically shorted together by conductive foam, aluminum foil or other conductive materials.
7. Immediately before removing the protective material from the leads of a replacement ESD, touch the protective material to the chassis or circuit assembly into which the device will be installed.
Caution: Be sure no power is applied to the chassis or circuit and observe all other safety precautions.
8. Minimize body motions when handling unpackaged replacement ESDs. Motions such as brushing clothes together, or lifting your foot from a carpeted floor can generate enough static electricity to damage an ESD.

2 Product Specifications

2-1 Specifications

Item	Description	
LCD Panel	TFT-LCD panel, RGB vertical stripe, normaly white, 15-Inch viewable, 0.297 mm pixel pitch	
Scanning Frequency	Horizontal : 30 kHz ~ 61 kHz (Automatic) Vertical : 56 Hz ~ 75 Hz (Automatic)	
Display Colors	16.7 Million colors	
Maximum Resolution	Horizontal : 1024 Pixels Vertical : 768 Pixels	
Input Video Signal	Analog 0.7 Vp-p \pm 5% positive at 75 Ω , internally terminated	
Input Sync Signal	Type : Seperate H/V Level : TTL level	
Maximum Pixel Clock rate	80 MHz	
Active Display Horizontal/Vertical	304.1 mm / 228.1 mm	
AC power voltage & Frequency	AC 90 ~ 264 Volts, 60 / 50 Hz \pm 3 Hz	
Power Consumption	45 W (Max)	
Dimensions Unit (W x D x H) Carton (W x D x H)	13.6 x 6.7 x 14.2 Inches (346.0 x 169.0 x 361.5 mm) 16.8 x 4.5 x 21.0 Inches (427 x 114 x 535 mm)	
Weight	3.2 Kg / 7.05 lbs (With Stand)	
Environmental Considerations	Operating Temperature : 50 °F ~ 104 °F (10 °C ~ 40 °C) Humidity : 10 % ~ 80 % Storage Temperature : -4 °F ~ 113 °F (-20 °C ~ 45 °C) Humidity : 5 % ~ 95 %	
TV System	Tunning	Frequency Synthesize
	System	NTSC-M
	Sound	STEREO
Antena Input	75 Ω , Coaxial Cable	
Sound Characteristic	– MAX Internal speaker Output : Right => 3W Left => 3W	
	– BASS Control Range : -12 dB~ + 12 dB – TREBLE Control Range : -12 dB~ + 12 dB – Headphone Out: 5mW max (400m Vrms) – Output Frequency : RF => 80 Hz ~ 15 kHz A/V => 80 Hz ~ 15 kHz	

2-2 Pin Assignments

2-2-1 D-SUB

Pin	Separate
1	Red
2	Green
3	Blue
4	GND
5	GND (DDC Return)
6	GND-Red
7	GND-Green
8	GND-Blue
9	No Connection
10	GND-Sync./Self Test
11	GND
12	DDC Data
13	H-Sync.
14	V-Sync.
15	DDC Clock

2-2-2 DVD, DTV

RCA Green	Y
	GND
RCA Blue	Pb (Cb)
	GND
RCA Red	Pr (Cr)
	GND
RCA White	Audio L
	GND
RCA Red	Audio R
	GND

2-2-3 S-Video

Pin	Separate
1	GND
2	Y
3	C
4	GND
5	GND

2-2-4 A/V

RCA Yellow	CVBS
RCA White	Audio L
	GND
RCA Red	Audio R
	GND

2-2-5 D4 CONNECTOR

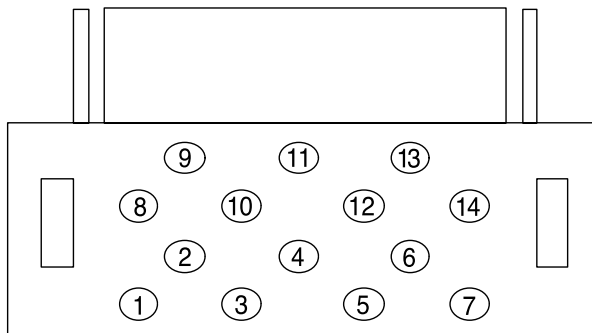
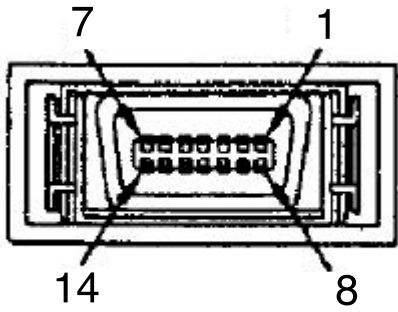

Pin	Separate
1	Y
2	Y_GNd
3	Pb
4	Pb_GNd
5	Pr
6	Pr_GNd
7	Preliminary Line1
8	Line1
9	Line5
10	Preliminary Line2
11	Line3
12	Switch GND
13	Prliminary Line3
14	Switch

	Line 1 (Resolution)	Line2 (i/p)	Line3 (Aspect)
5V	1080	60p	16 : 9
2.2V	720	-	letter box
0V	480	60i	4 : 3

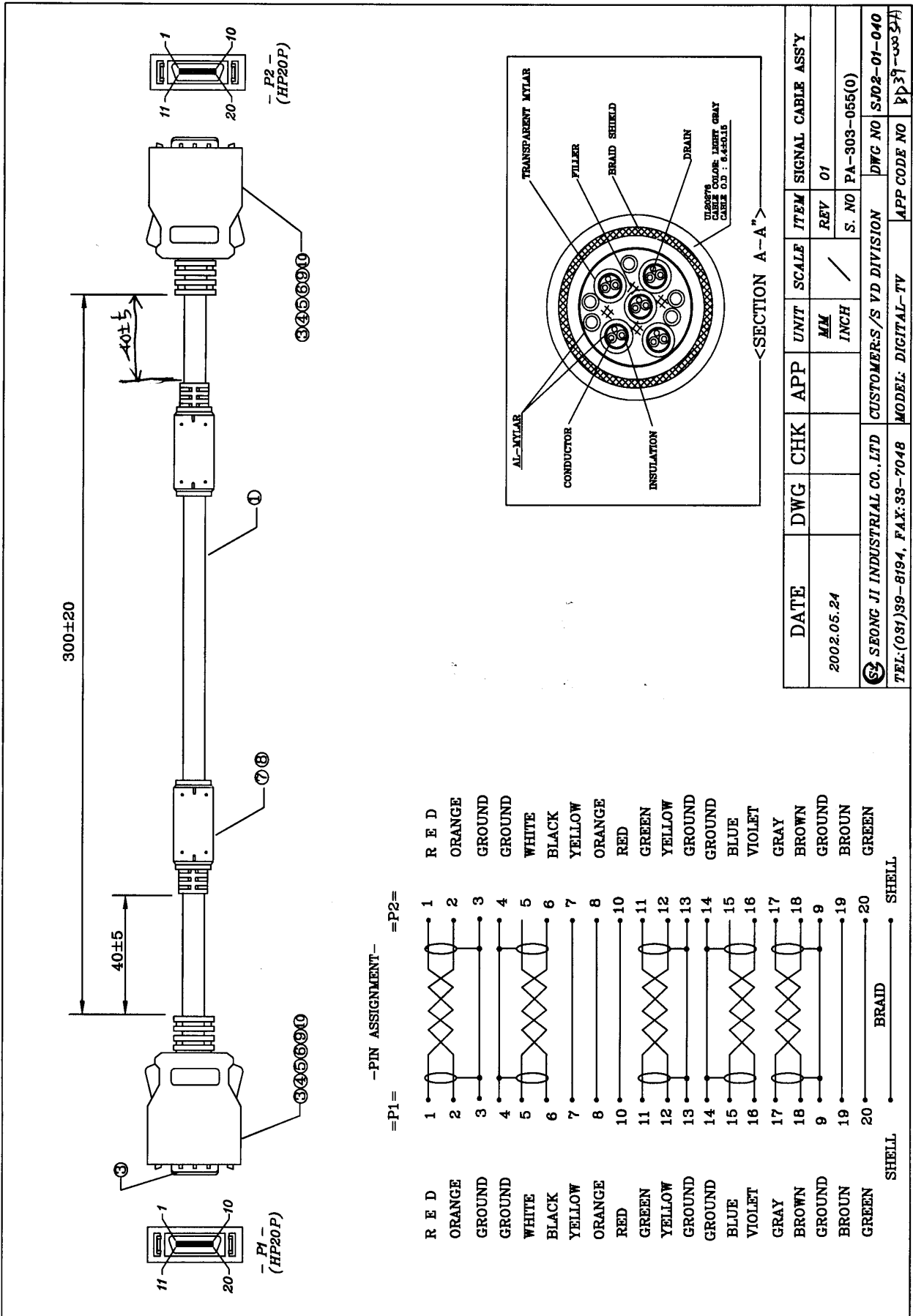

-PIN ASSIGNMENT-
=P1=
=P2=

RED	1	1	RED
ORANGE	2	2	ORANGE
GROUND	3	3	GROUND
GROUND	4	4	GROUND
WHITE	5	5	WHITE
BLACK	6	6	BLACK
YELLOW	7	7	YELLOW
ORANGE	8	8	ORANGE
RED	10	10	RED
GREEN	11	11	GREEN
YELLOW	12	12	YELLOW
GROUND	13	13	GROUND
GROUND	14	14	GROUND
BLUE	15	15	BLUE
VIOLET	16	16	VIOLET
GRAY	17	17	GRAY
BROWN	18	18	BROWN
GROUND	9	9	GROUND
BROWN	19	19	BROWN
GREEN	20	20	GREEN
SHELL			SHELL
			BRAID

DATE	DWG	CHK	APP	UNIT	SCALE	ITEM	SIGNAL CABLE ASSY
2002.05.24				MM INCH	/	REV 01	
SEONG JI INDUSTRIAL CO., LTD						S. NO PA-303-055(0)	DWC NO SJ02-01-040
TEL:(091)39-8194, FAX:33-7048						MODEL: DIGITAL-TV	APP CODE NO 337-333A

CONFIDENTIAL

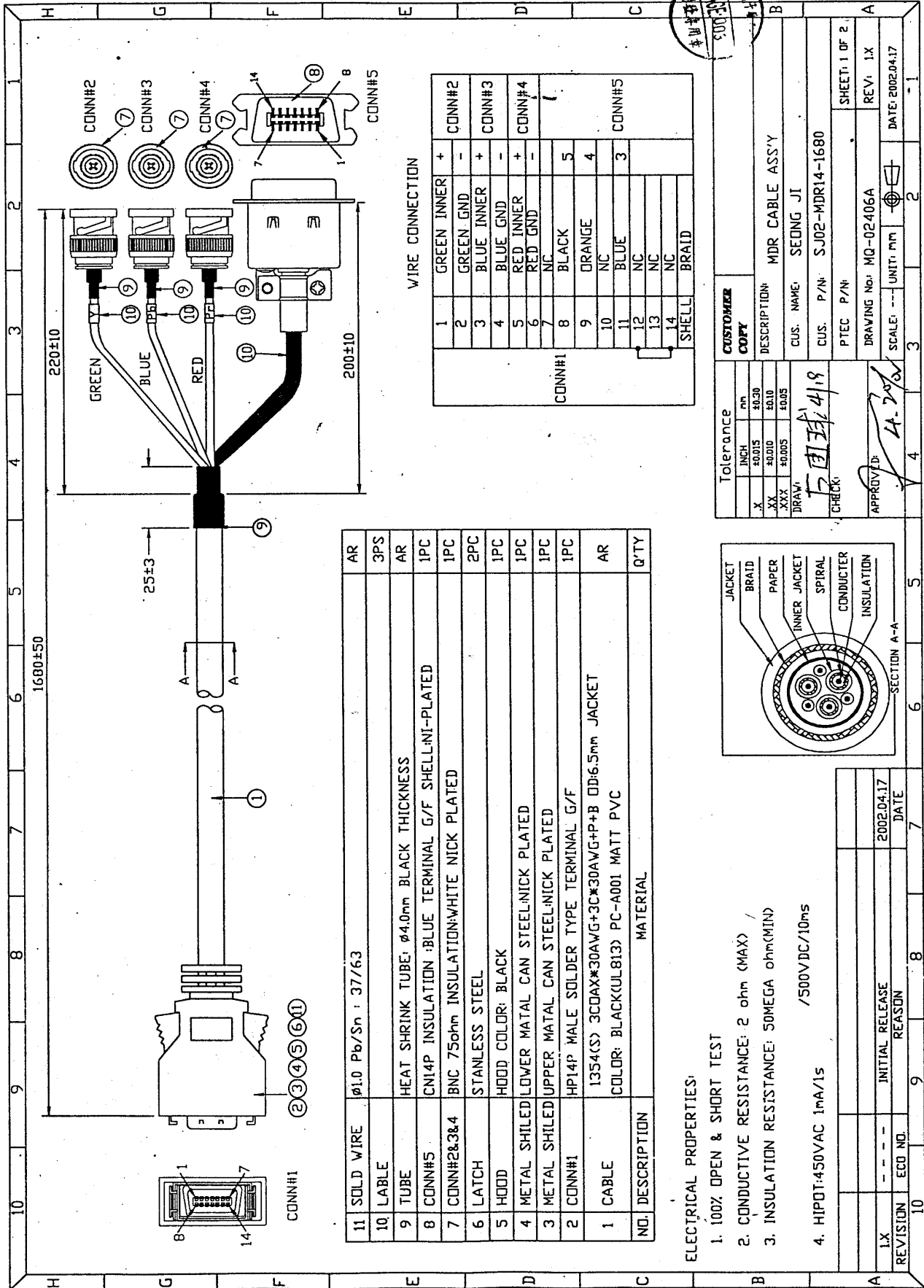

WIRE CONNECTION

CONN#1	CONN#2	CONN#3	CONN#4	CONN#5
1	GREEN INNER +			
2	GREEN GND -			
3	BLUE INNER +			
4	BLUE GND -			
5	RED INNER -			
6	RED GND -			
7	NC			
8	BLACK			
9	ORANGE			
10	NC			
11	BLUE			
12	NC			
13	NC			
14	NC			
	SHELL			
	BRAID			

NO.	DESCRIPTION	MATERIAL	Q'TY
11	SOLD WIRE	Ø1.0 Pb/Sn : 37/63	AR
10	CABLE		3PS
9	TUBE	HEAT SHRINK TUBE: Ø4.0mm BLACK THICKNESS	AR
8	CONN#5	CNI4P INSULATION :BLUE TERMINAL G/F SHELL-NI-PLATED	IPC
7	CONN#2&3&4	BNC 75ohm INSULATION:WHITE NICK PLATED	IPC
6	LATCH	STAINLESS STEEL	2PC
5	HOOD	HOOD COLOR: BLACK	1PC
4	METAL SHIELDED	LOWER METAL CAN STEEL-NICK PLATED	1PC
3	METAL SHIELDED	UPPER METAL CAN STEEL-NICK PLATED	1PC
2	CONN#1	HP14P MALE SOLDER TYPE TERMINAL G/F	1PC
1	CABLE	1354(S) 3COAX*30AVG+3C*30AVG+P+B OD:6.5mm JACKET COLOR: BLACK(UL813) PC-A001 MATT PVC	AR

Tolerance	CUSTOMER
INCH	COPY
.X	±0.015
XX	±0.010
XXX	±0.005
DRAW	DESCRIPTION: MDR CABLE ASS'Y
CHECK	CUS. NAME: SEONG JI
APPROVE	CUS. P/N: SJ02-MDR14-1680
	PTEC P/N:
	DRAWING NO: MQ-02-406A
	SCALE: --- UNIT: mm
	SHEET: 1 OF 2
	REV: 1X
	DATE: 2002.04.17

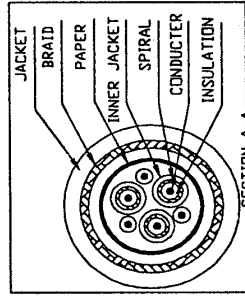

- ELECTRICAL PROPERTIES:
- 100% OPEN & SHORT TEST
 - CONDUCTIVE RESISTANCE: 2 ohm (MAX) /
 - INSULATION RESISTANCE: SOME OMEGA ohm(MIN) /500VDC/10ms
 - HIPOT:450VAC 1mA/1s

REVISION	ECD NO.	INITIAL RELEASE REASON	DATE
1X	---	INITIAL RELEASE	2002.04.17

2-3 Timing Chart

This section of the service manual describes the timing that the computer industry recognizes as standard for computer-generated video signals.

2-3-1 LCD Panel Mode : 1 mode

Timing No.	15
Originator	VESA
Mode Name	1024/60Hz
Resolution (HxV)	1024x768
HORIZONTAL	
Frequency	48.363kHz
Total time	20.677μs
Active time	15.754μs
Blank time	4.923μs
Border (L / R)	0.000μs
Data time	15.754μs
Front porch	0.369μs
Sync. width	2.092μs
Back porch	2.462μs
Sync. polarity	Negative
VERTICAL	
Frequency	60.004Hz
Total time	16.666ms
Active time	15.880ms
Blank time	0.786ms
Border (T / B)	0.000ms
Data time	15.880ms
Front porch	0.062ms
Sync. width	0.124ms
Back porch	0.600ms
Sync. polarity	Negative
Dot Clock	65.000MHz
Sync. Type	Separate
Scan Type	N/I

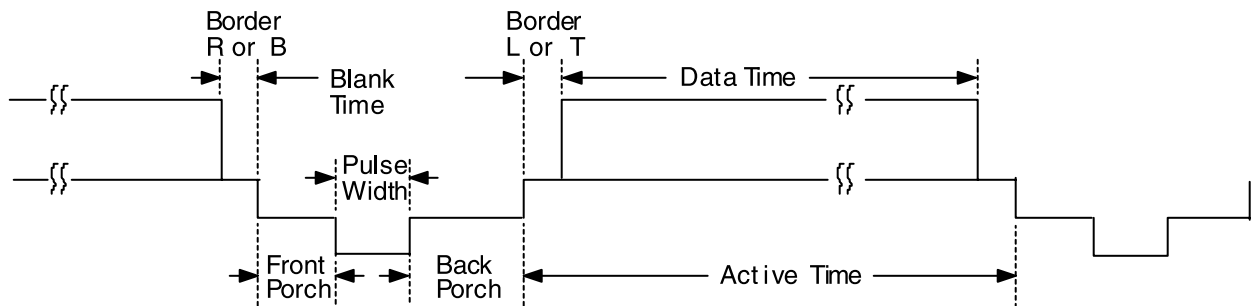

2-3-2 Supported Modes (1)

Timing No.	2	3	11	17	32
Originator	IBM	IBM	VESA	VESA	MAC
Mode Name	VGA2	VGA3	640/72Hz	640/75Hz	640/67Hz
Resolution (HxV)	720x400	640x480	640x480	640x480	640x480
HORIZONTAL					
Frequency	31.469kHz	31.469kHz	37.861kHz	37.500kHz	35.000kHz
Total time	31.777 μ s	31.778 μ s	26.413 μ s	26.667 μ s	28.571 μ s
Active time	26.058 μ s	26.058 μ s	20.825 μ s	20.317 μ s	21.164 μ s
Blank time	5.720 μ s	5.720 μ s	5.588 μ s	6.350 μ s	7.407 μ s
Border (L / R)	0.318 μ s	0.318 μ s	0.254 μ s	0.000 μ s	0.000 μ s
Data time	25.422 μ s	25.422 μ s	20.317 μ s	20.317 μ s	21.164 μ s
Front porch	0.318 μ s	0.318 μ s	0.508 μ s	0.508 μ s	2.116 μ s
Sync. width	3.813 μ s	3.813 μ s	1.270 μ s	2.032 μ s	2.116 μ s
Back porch	1.589 μ s	1.589 μ s	3.810 μ s	3.810 μ s	3.175 μ s
Sync. polarity	Negative	Negative	Negative	Negative	Negative
VERTICAL					
Frequency	70.087Hz	59.940Hz	72.809Hz	75.000Hz	66.667Hz
Total time	14.268ms	16.683ms	13.735ms	13.333ms	15.000ms
Active time	13.155ms	15.761ms	13.100ms	12.800ms	13.714ms
Blank time	1.113ms	0.922ms	0.635ms	0.533ms	1.286ms
Border (T / B)	0.222ms	0.254ms	0.211ms	0.000ms	0.000ms
Data time	12.711ms	15.253ms	12.678ms	12.800ms	13.714ms
Front porch	0.191ms	0.064ms	0.026ms	0.027ms	0.086ms
Sync. width	0.064ms	0.064ms	0.079ms	0.080ms	0.086ms
Back porch	0.858ms	0.794ms	0.528ms	0.427ms	1.114ms
Sync. polarity	Positive	Negative	Negative	Negative	Negative
Dot Clock	28.322MHz	25.175MHz	31.500MHz	31.500MHz	30.240MHz
Sync. Type	Separate	Separate	Separate	Separate	Separate
Scan Type	N/I	N/I	N/I	N/I	N/I

2-3-2 Supported Modes (2)

Timing No.	13	14	18	33	16
Originator	VESA	VESA	VESA	MAC	VESA
Mode Name	800/60Hz	800/72Hz	800/75Hz	832/75Hz	1024/70Hz
Resolution (HxV)	800x600	800x600	800x600	832x624	1024x768
HORIZONTAL					
Frequency	37.879kHz	48.077kHz	46.875kHz	49.726kHz	56.476kHz
Total time	26.400μs	20.800μs	21.333μs	20.110μs	17.707μs
Active time	20.000μs	16.000μs	16.162μs	14.524μs	13.653μs
Blank time	6.400μs	4.800μs	5.171μs	5.171μs	4.053μs
Border (L / R)	0.000μs	0.000μs	0.000μs	0.000μs	0.000μs
Data time	20.000μs	16.000μs	16.162μs	14.524μs	13.653μs
Front porch	1.000μs	1.120μs	0.323μs	0.559μs	0.320μs
Sync. width	3.200μs	2.400μs	1.616μs	1.117μs	1.813μs
Back porch	2.200μs	1.280μs	3.232μs	3.910μs	1.920μs
Sync. polarity	Positive	Positive	Positive	Positive	Negative
VERTICAL					
Frequency	60.317Hz	72.188Hz	75.000Hz	74.551Hz	70.069Hz
Total time	16.579ms	13.853ms	13.333ms	13.414ms	14.272ms
Active time	15.840ms	12.480ms	12.800ms	12.549ms	13.599ms
Blank time	0.739ms	1.373ms	0.533ms	0.864ms	0.672ms
Border (T / B)	0.000ms	0.000ms	0.000ms	0.000ms	0.000ms
Data time	15.840ms	12.480ms	12.800ms	12.549ms	13.599ms
Front porch	0.026ms	0.770ms	0.021ms	0.020ms	0.053ms
Sync. width	0.106ms	0.125ms	0.064ms	0.060ms	0.106ms
Back porch	0.607ms	0.478ms	0.448ms	0.784ms	0.513ms
Sync. polarity	Positive	Positive	Positive	Positive	Negative
Dot Clock	40.000MHz	50.000MHz	49.500MHz	49.500MHz	75.000MHz
Sync. Type	Separate	Separate	Separate	Separate	Separate
Scan Type	N/I	N/I	N/I	N/I	N/I

2-3-2 Supported Modes (3)

Timing No.	19
Originator	VESA
Mode Name	1024/75Hz
Resolution (HxV)	1024x768
HORIZONTAL	
Frequency	60.023kHz
Total time	16.660 s
Active time	13.003 s
Blank time	3.777 s
Border (L / R)	0.000 s
Data time	13.003 s
Front porch	0.323 s
Sync. width	1.219 s
Back porch	2.235 s
Sync. polarity	Positive
VERTICAL	
Frequency	75.029Hz
Total time	13.328ms
Active time	12.795ms
Blank time	0.533ms
Border (T / B)	0.000ms
Data time	12.795ms
Front porch	0.017ms
Sync. width	0.050ms
Back porch	0.466ms
Sync. polarity	Positive
Dot Clock	78.750MHz
Sync. Type	Separate
Scan Type	N/I

Memo

3 Disassembly and Reassembly

This section of the service manual describes the disassembly and reassembly procedures for the LTM1525/LT15S13C monitor.

WARNING: This monitor contains electrostatically sensitive devices. Use caution when handling these components.

3-1 Disassembly

- Cautions:**
1. Disconnect the monitor from the power source before disassembly.
 2. Follow these directions carefully; never use metal instruments to pry apart the cabinet.

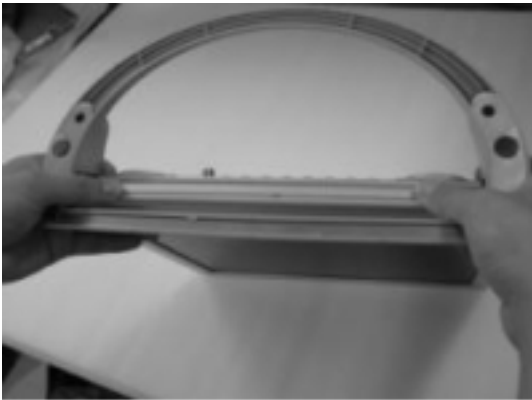

1. The stand is held into the bottom of the unit by a pair of retaining clips (near the left and right hinges). To remove the stand, simply pull it away from the unit and the retaining clips will release automatically.



2. Remove the two Phillips screws (left and right).



3. Separate the case halves (front/back) starting at the bottom/edges.

3-2 Reassembly

Reassembly procedures are in the reverse order of Disassembly procedures.

4 Alignments and Adjustments

4-1 General Alignment Instruction

1. Usually, a color TV-VCR needs only slight touch-up adjustment upon installation. Check the basic characteristics such as height, horizontal and vertical sync.
2. Use the specified test equipment or its equivalent.
3. Correct impedance matching is essential.
4. Avoid overload. Excessive signal from a sweep generator might overload the front-end of the TV. When inserting signal markers, do not allow the marker generator to distort test result.
5. Connect the TV only to an AC power source with voltage and frequency as specified on the backcover nameplate.
6. Do not attempt to connect or disconnect any wire while the TV is turned on. Make sure that the power cord is disconnected before replacing any parts.
7. To protect against shock hazard, use an isolation transform.

4-2 Factory Mode Adjustments

4-2-1 Entering Factory Mode

1. To enter "Service Mode" Press the remote -control keys in this sequence :

- If you do not have Factory remote - control

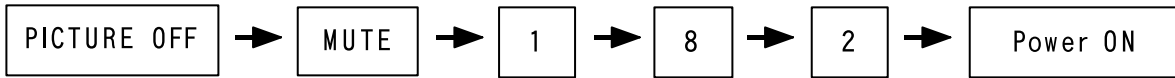

- If you have Factory remote - control



4-2-2 Factory Mode Tree (U.S. Only)

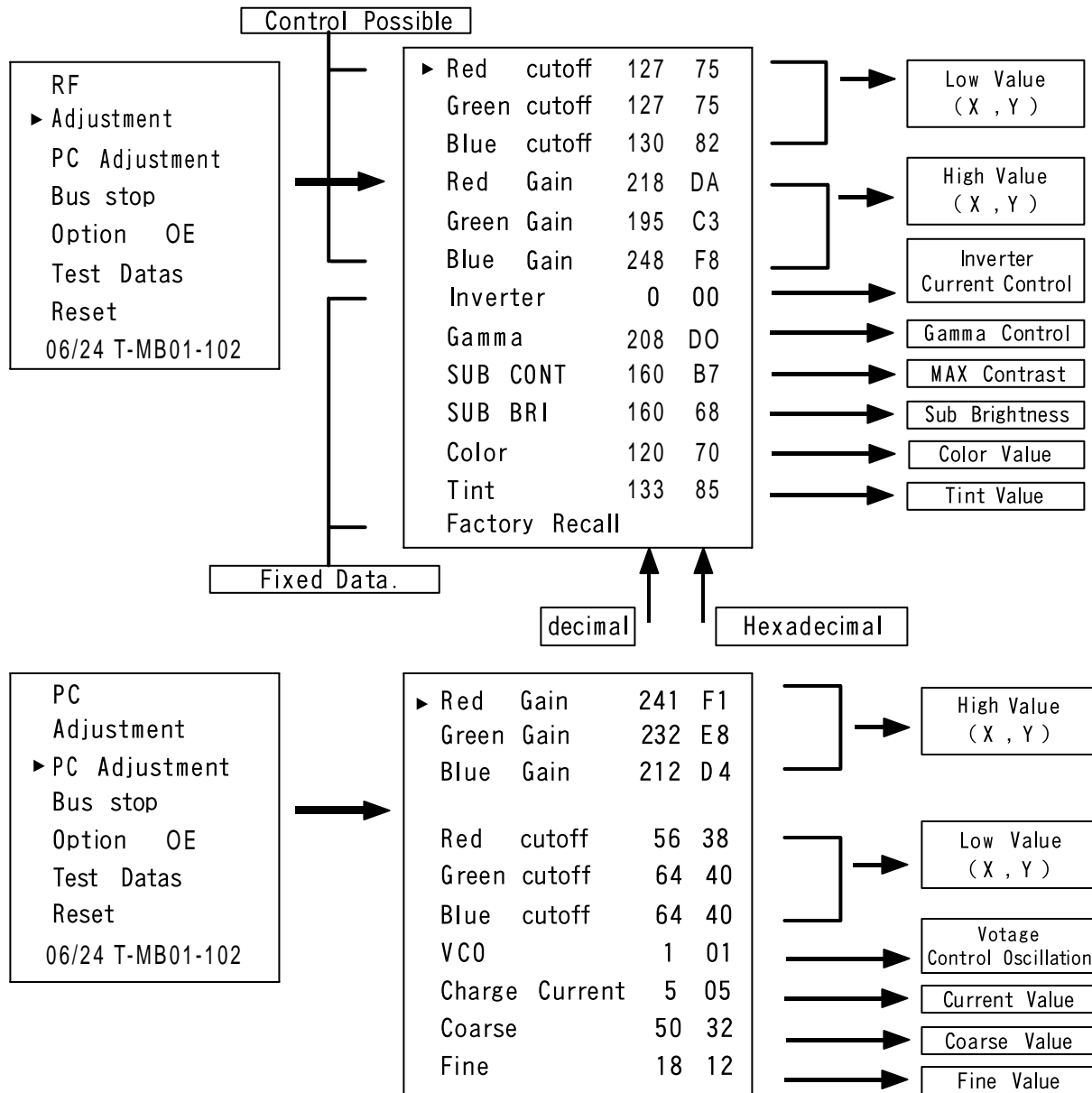

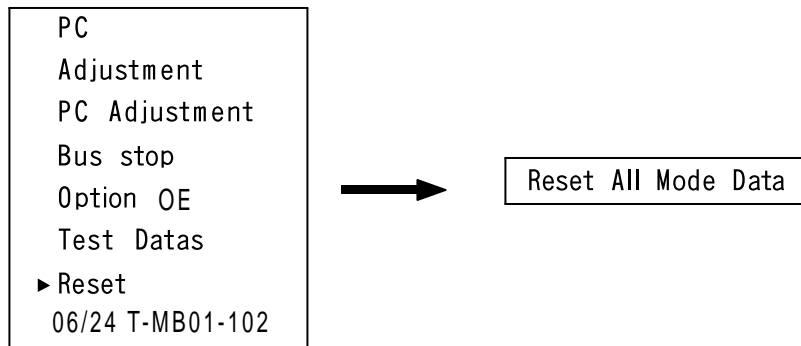
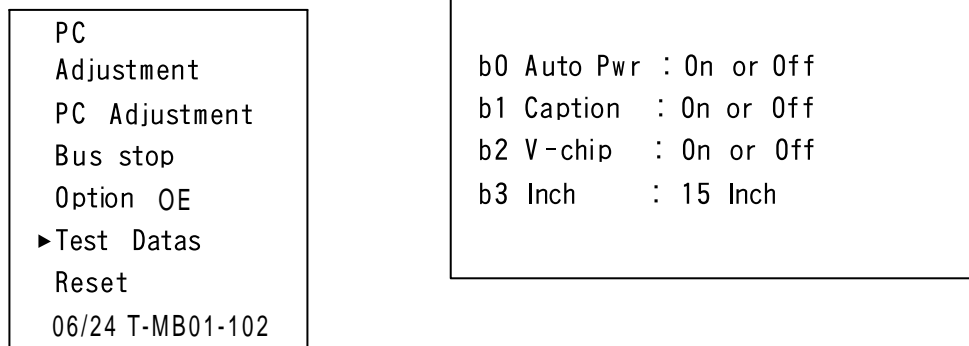
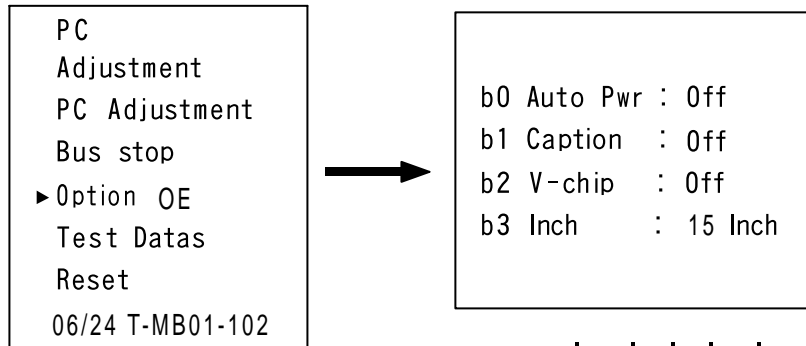
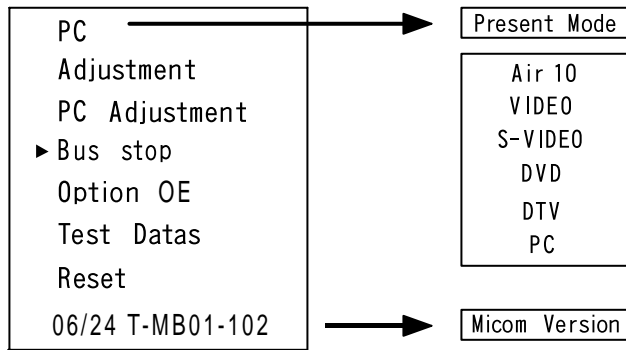

4-2-3 Factory Mode Tree (Japan Only)

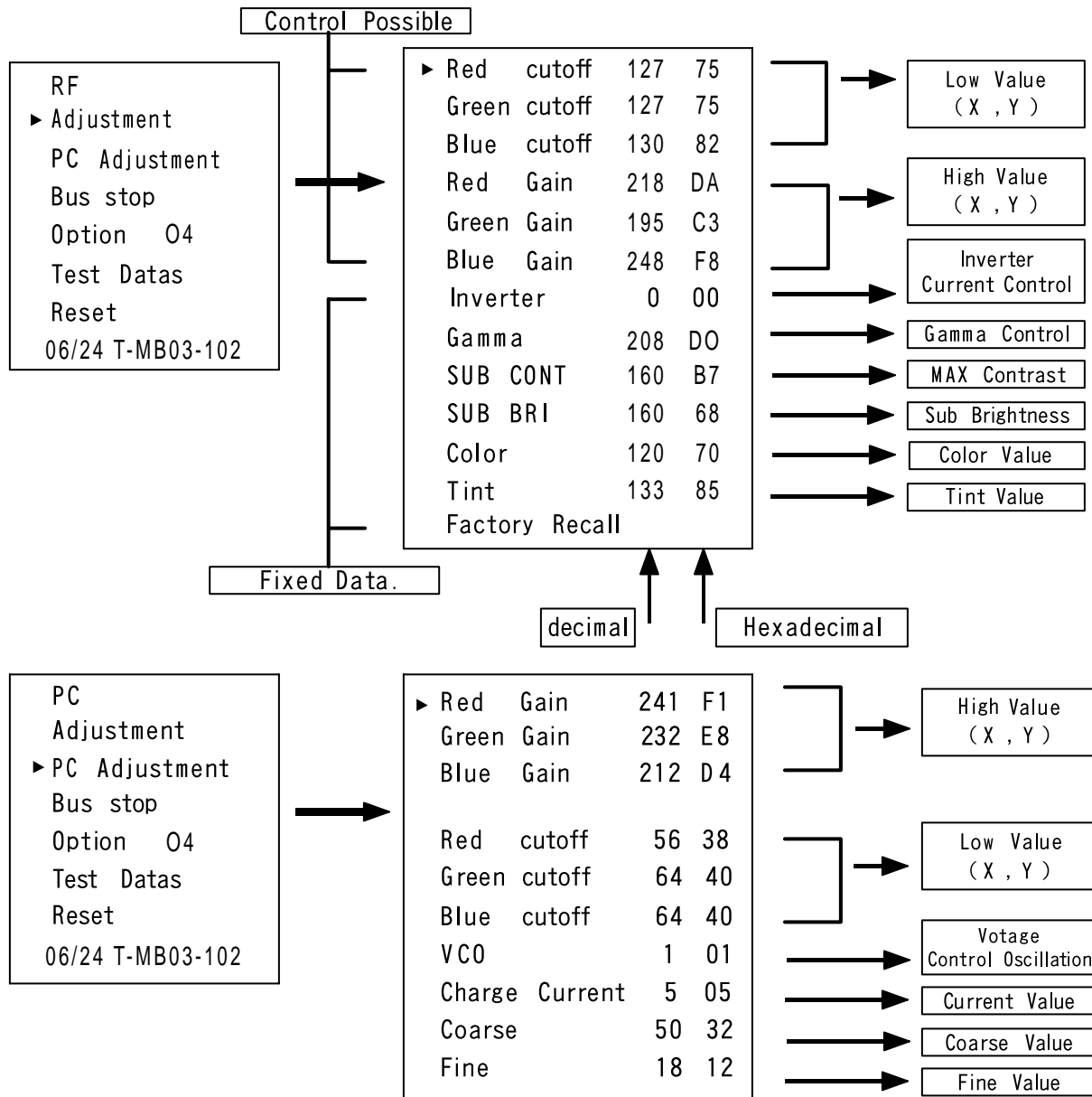

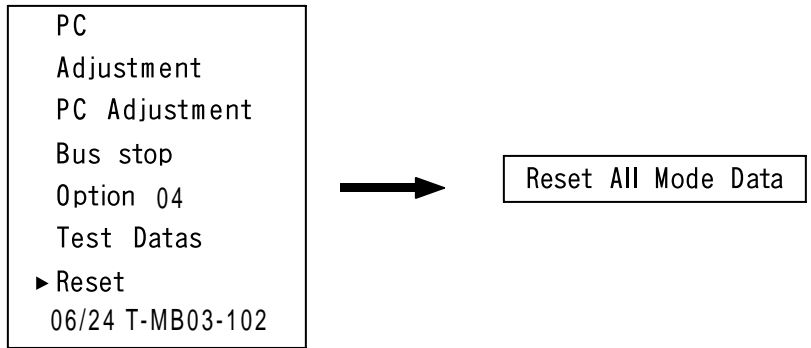
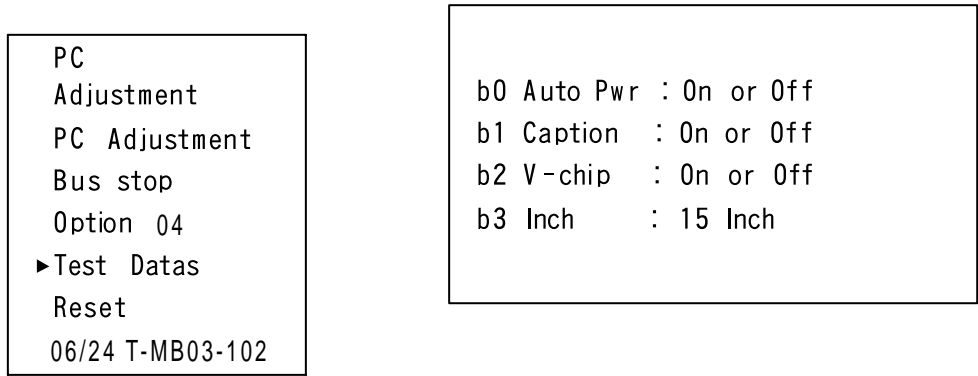
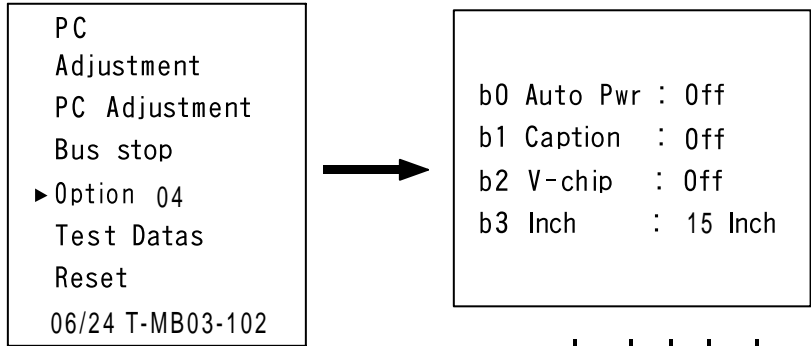
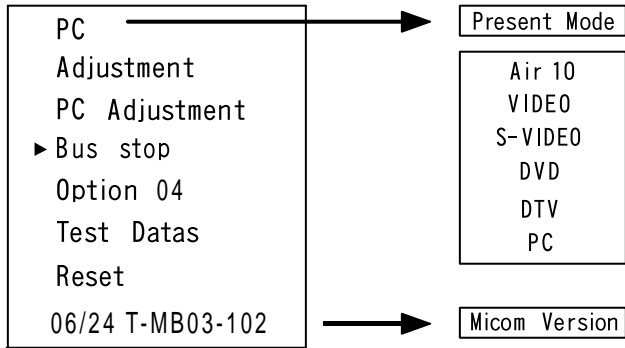

Memo

5 Troubleshooting

5-1 No Power

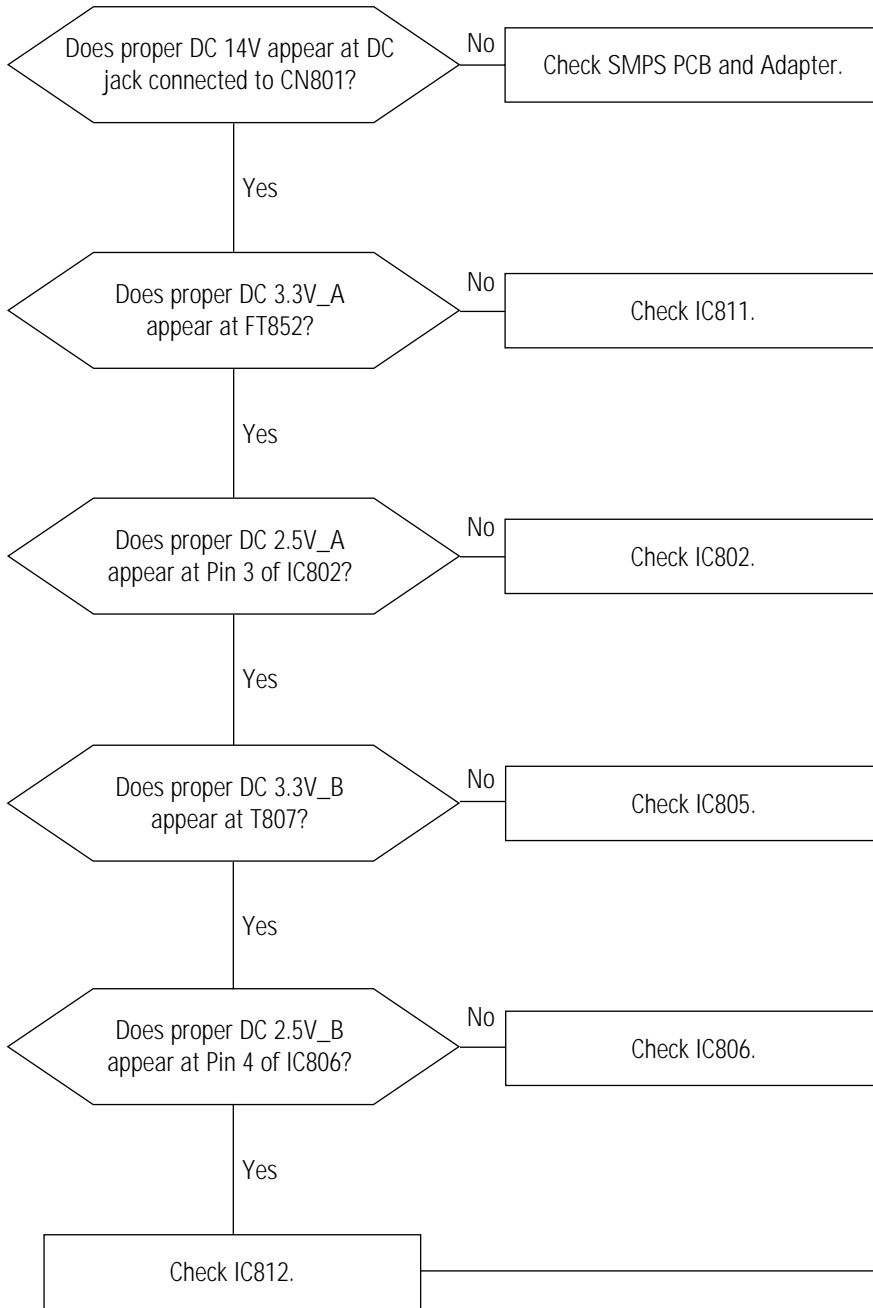

WAVEFORMS

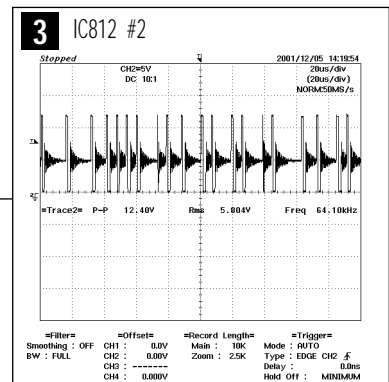
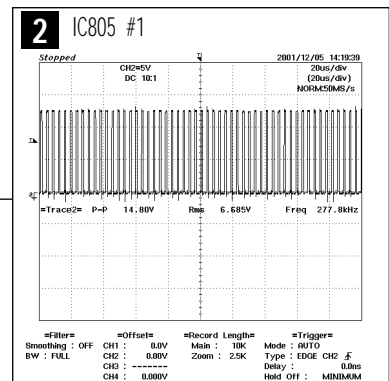
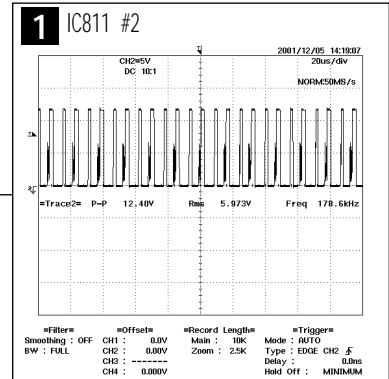

5-2 No Video (PC Signal)

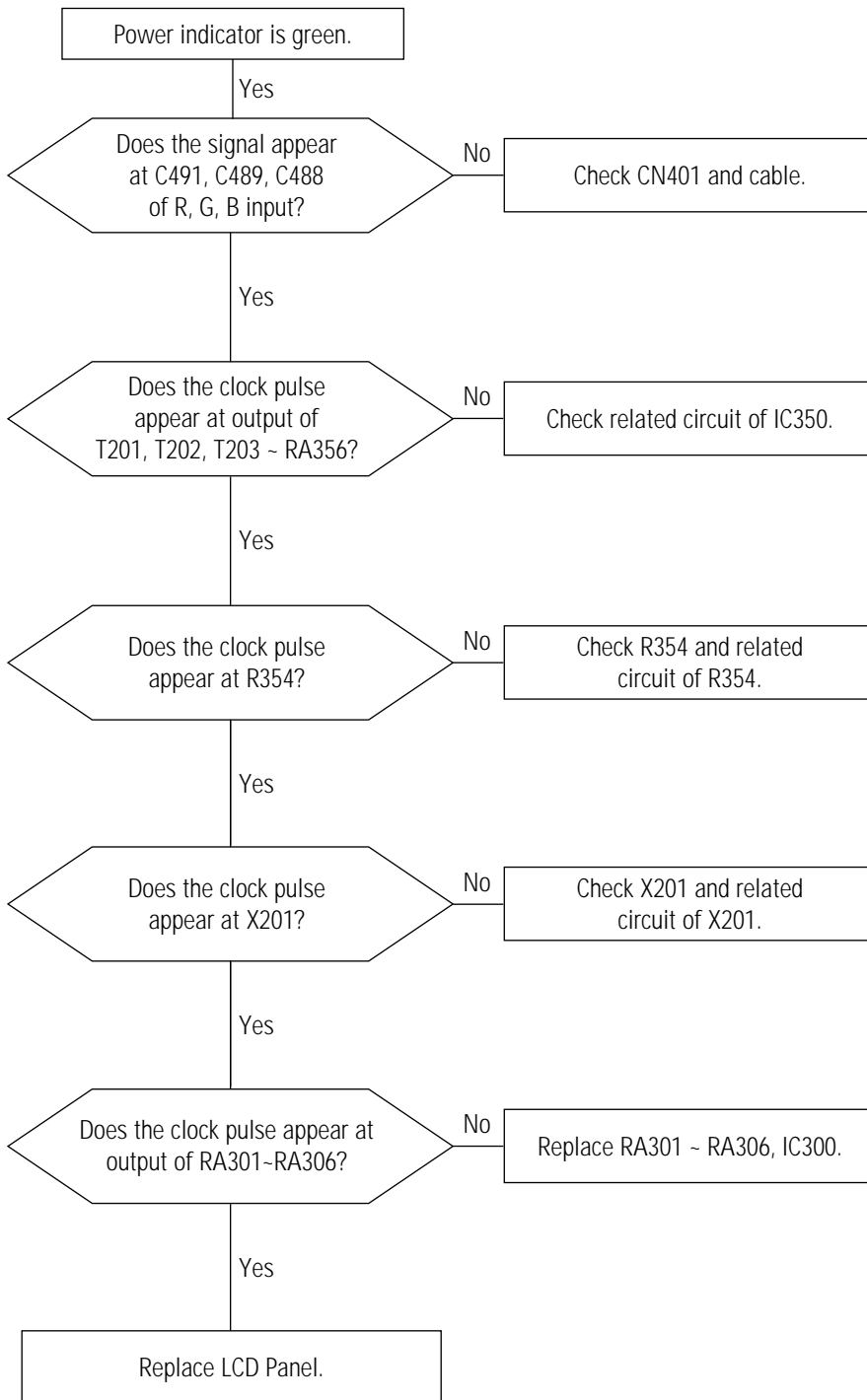

WAVEFORMS

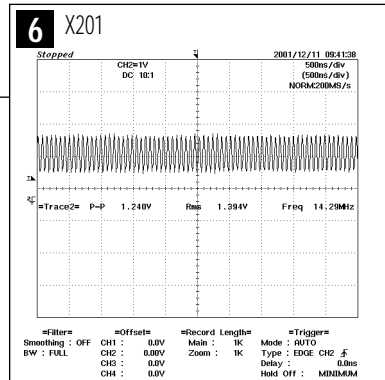
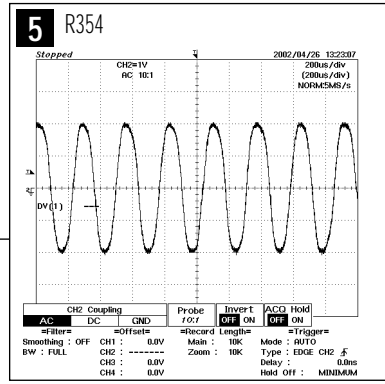
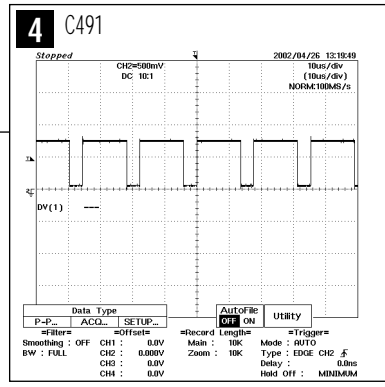

5-3 No Picture (TV, Video, S-Video, DVD, DTV)

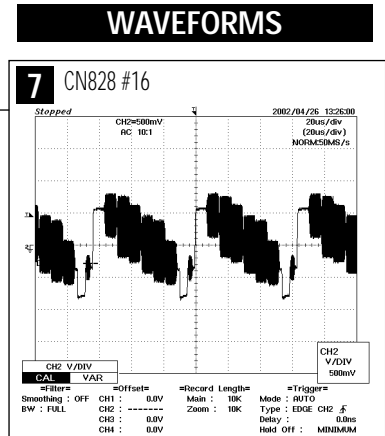
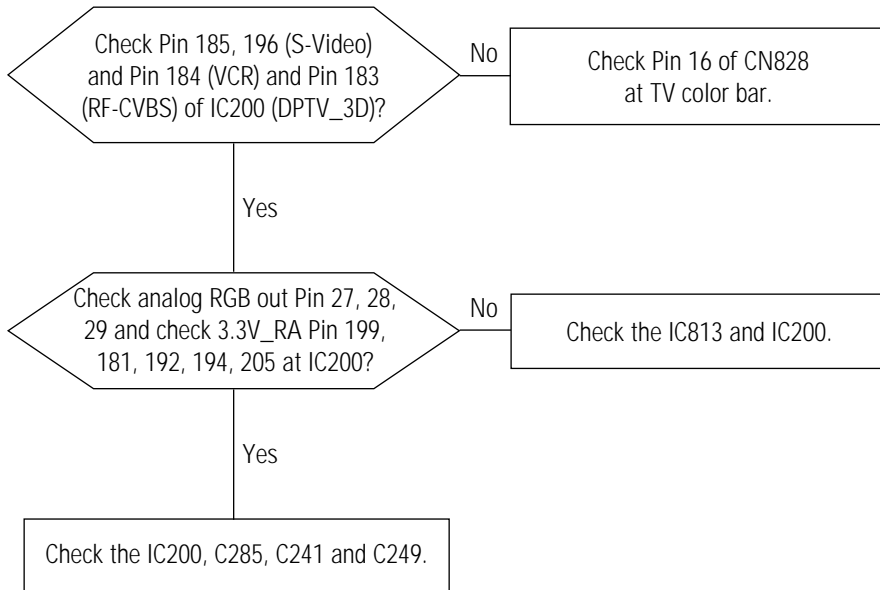

5-4 No Sound

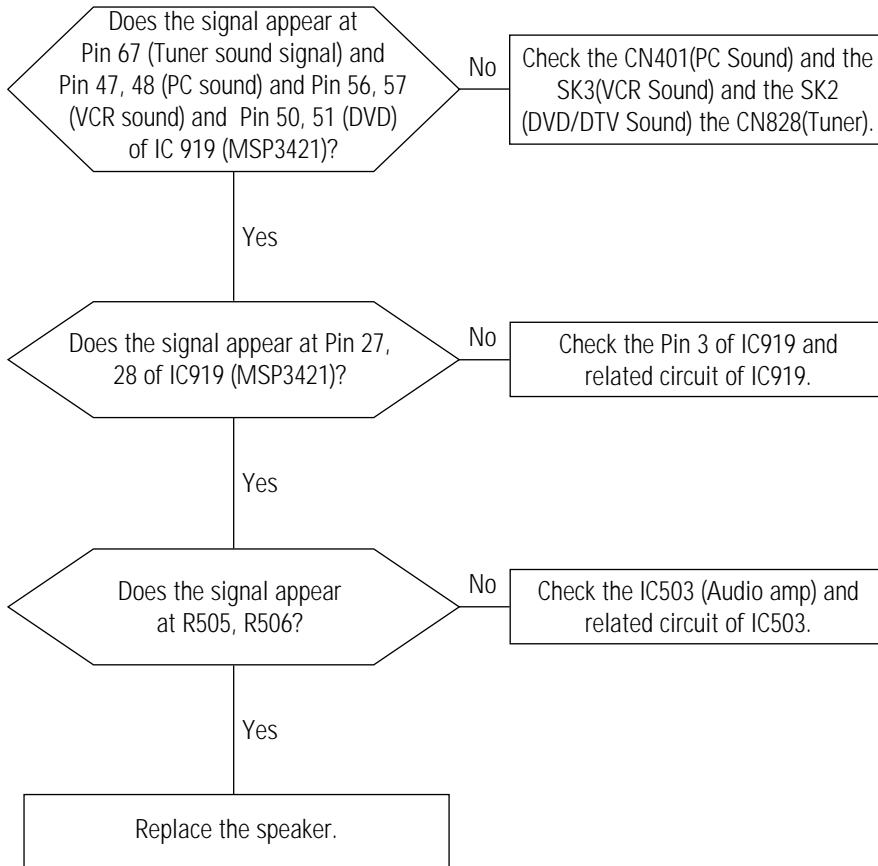

WAVEFORMS

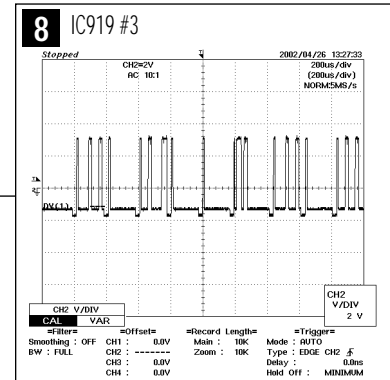

6 Exploded View and Parts List

NO	DESCRIPTION	PART CODE-NO	SPECIFICATION	Q'TY	MODEL	REMARK
1	ASSY COVER-FRONT	BN90-00255D	ABS HB,GR70,SVM-1207	1	MB15JO	SA
		BN90-00255C	ABS HB,GR70,SVM-1207	1	MB15UO	SA
2	ASSY STAND	BN90-00257A	ABS HB GR70 SVM-1207	1		SA
3	LCD PANEL	-	-	1		-
4	COVER-PCB	BN63-00174A	ABS+PC 5V IV16	1		SNA
5	INVERTER PCB	-	-	1		-
6	MAIN PCB	-	-	1		-
7	ASSY SHIELD PCB	BN90-00256A	SECC 10.5	1		SNA
8	SCREW TAPTITE	6003-000117	BH,+ ,B,M3,L6,ZPC(YEL),SWRCH18A	10		SA
9	ASSY COVER-REAR	BN96-00038D	ABS HB GR70 SVM-1207	1	MB15JO	SA
		BN96-00038B	ABS VO GR70 SVM-1207	1	MB15UO	SA
10	SCREW TAPTITE	6003-001246	FH,+ ,B,M3,L10,Ni PLT,SWRCH18A	2		SA
11	INPUT BOARD	-	-	1		-

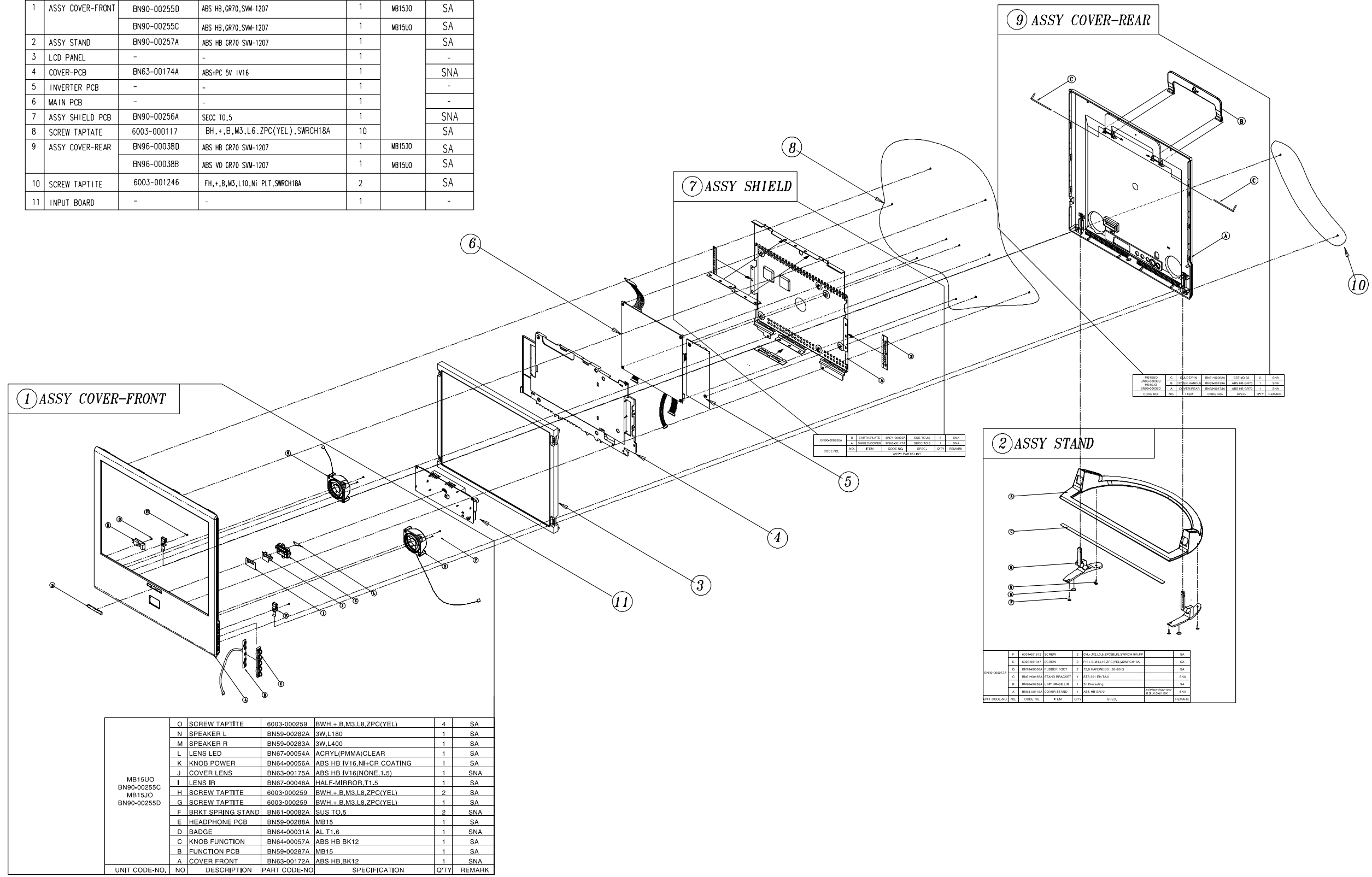

UNIT CODE-NO.	NO	DESCRIPTION	PART CODE-NO	SPECIFICATION	Q'TY	REMARK
MB15UO BN90-00255C MB15JO BN90-00255D	O	SCREW TAPTITE	6003-000259	BWH,+ B.M3,L8,ZPC(YEL)	4	SA
	N	SPEAKER L	BN59-00282A	3W,L180	1	SA
	M	SPEAKER R	BN59-00283A	3W,L400	1	SA
	L	LENS LED	BN67-00054A	ACRYL(PMMA)CLEAR	1	SA
	K	KNOB POWER	BN64-00056A	ABS HB IV16,NH+CR COATING	1	SA
	J	COVER LENS	BN63-00175A	ABS HB IV16(NONE,1.5)	1	SNA
	I	LENS IR	BN67-00048A	HALF-MIRROR,T1.5	1	SA
	H	SCREW TAPTITE	6003-000259	BWH,+ B.M3,L8,ZPC(YEL)	2	SA
	G	SCREW TAPTITE	6003-000259	BWH,+ B.M3,L8,ZPC(YEL)	1	SA
	F	BRKT SPRING STAND	BN61-00082A	SUS TO.5	2	SNA
	E	HEADPHONE PCB	BN59-00288A	MB15	1	SA
	D	BADGE	BN64-00031A	AL T1.6	1	SNA
	C	KNOB FUNCTION	BN64-00057A	ABS HB BK12	1	SA
	B	FUNCTION PCB	BN59-00287A	MB15	1	SA
A	COVER FRONT	BN63-00172A	ABS HB,BK12	1	SNA	

UNIT CODE-NO.	NO	DESCRIPTION	PART CODE-NO	SPECIFICATION	Q'TY	REMARK
BN90-00255D	C	COVER HANDLE	BN63-00174A	ABS+PC 5V IV16	1	SNA
	B	COVER HANDLE	BN63-00174A	ABS+PC 5V IV16	1	SNA
BN90-00255C	A	COVER HANDLE	BN63-00174A	ABS+PC 5V IV16	1	SNA
	B	COVER HANDLE	BN63-00174A	ABS+PC 5V IV16	1	SNA

UNIT CODE-NO.	NO	DESCRIPTION	PART CODE-NO	SPECIFICATION	Q'TY	REMARK
BN90-00256A	B	SHIELD BRACKET	BN63-00174A	ABS+PC 5V IV16	1	SNA
	A	SHIELD BRACKET	BN63-00174A	ABS+PC 5V IV16	1	SNA

UNIT CODE-NO.	NO	DESCRIPTION	PART CODE-NO	SPECIFICATION	Q'TY	REMARK
BN90-00257A	F	SCREW	6003-000259	BWH,+ B.M3,L8,ZPC(YEL),SWRCH18A,PT	1	SA
	E	SCREW	6003-000259	BWH,+ B.M3,L8,ZPC(YEL),SWRCH18A,PT	1	SA
	D	SCREW	6003-000259	BWH,+ B.M3,L8,ZPC(YEL),SWRCH18A,PT	1	SA
	C	SCREW	6003-000259	BWH,+ B.M3,L8,ZPC(YEL),SWRCH18A,PT	1	SA
BN90-00257A	B	STAND BRACKET	BN61-00082A	SUS TO.5	1	SNA
	A	STAND BRACKET	BN61-00082A	SUS TO.5	1	SNA
	A	COVER STAND	BN61-00082A	SUS TO.5	1	SNA

Memo

BN90-00297A	-	ASSY COVER REAR	MB15UO	SNA
6003-001246	C/F+C/R	SCREW-TAPTITE	FH,+ ,B,M3,L10,NI PLT,SWRCH18A	SNA
BN96-00038B	CIS	ASSY COVER P-REAR	MB15UO,USA,ABS HB,SVM-1207	
BN61-00092A	CIS	BRACKET-PIN	RB15,CU+ZN,TO.23,35MM	SNA
BN63-00173A	CIS	COVER-REAR	RB15,ABS,-,-,-,HB,-,BK08,SILVER SPRAY	SNA
BN63-00199A	CIS	COVER-HANDLE	RB15,ABS,HB,BK08,HB,1.5	SNA
BN90-00318A	-	ASSY STAND	MB15NO	SNA
BN90-00257A	CIS	ASSY STAND	RB15,-,ABD HB,-,-,-,-	
6001-001612	CIS	SCREW-MACHINE	CH,+ ,M2,L3.5,ZPC(BLK),SWRCH18A,FP,-	
6003-001347	CIS	SCREW-TAPTITE	FH,+ ,B,M4,L16,ZPC(YEL),SWRCH18A,-	SNA
BN61-00158A	CIS	BRACKET-STAND	MINERVA,STS 420J2,T2.0	SNA
BN63-00176A	CIS	COVER-STAND	RB15,ABS,-,-,-,HB,-,BK08,HB,1.5	SNA
BN73-60002A	CIS	RUBBER-FOOT	CY15PO,SPONGE,-,-,-,BL,-,-,-,-	SNA
BN90-00258A	CIS	ASSY HINGE	RB15,-,AL,-,-,-,-,DIE-CASTING	SNA
BN90-00341A	-	ASSY COVER FRONT	MB15UO	SNA
BN90-00255C	CIS	ASSY COVER FRONT	MB15UO,USA,ABS V0,SVM-1207	
6003-000259	CIS	SCREW-TAPTITE	BH,+ ,B,M3,L8,ZPC(YEL),SWRCH18A	SNA
BN59-00282A	CIS	SPEAKER SYSTEM	MINERVA,MINERVA-R,3W,46X46X20,3W 40HM, WIRE:395MM	
BN59-00283A	CIS	SPEAKER SYSTEM	MINERVA,MINERVA-L,3W,46X46X20,3W 40HM, WIRE:110MM	
BN59-00287A	CIS	BOARD-FUNCTION ASS'Y	MB15UO,CT5000-0610,FUNCTION ASS'Y	SNA
BN59-00288A	CIS	BOARD-PHONE JACK ASS'Y	MB15UO,CT5000-0620,PHONE-JACK ASS'Y	SNA
BN61-00082A	CIS	BRACKET-SPRING-STAND	RB15,SUS,TO.5,-,-,-,-	SNA
BN63-00172A	CIS	COVER-FRONT	RB15,ABS,-,-,-,HB,-,BK08,SILVER SPRAY	SNA
BN63-00175A	CIS	COVER-LENS	RB15,ABS,-,-,-,HB,-,IV16,NONE,1.5	SNA
BN64-00031A	CIS	BADGE-BRAND	RB15AS,AL,T1.4,6.3,40.1,-,SILIVER,-	SNA
BN64-00056A	CIS	KNOB-POWER	RB15,PC,-,-,-,HB,CLEAR,-,NI-CR	
BN64-00057A	CIS	KNOB-FUNCTION	RB15,ABS+PC,-,-,-,HB,BK08,-,NONE,1.5	
BN67-00048A	CIS	LENS-IR	RB15,ACRYL,CLEAR,-,1.5,-,HALF-MIRROR	SNA
BN67-00054A	CIS	LENS-LED	RB15,ACRYL,CLEAR,1	
BN91-00220A	-	ASSY LCD	ES15AS	SNA
BN07-00053A	CIS	LCD	LTM150XH-L06,CZB,6BIT_ FRC,331.6*254.76*12.5,16.19M,-,0.297*0.297,-,-,AMLCD/1 LV	
BN91-00310F	CIS	ASSY MISC	MB15	SNA
BN44-00063A	CIS	ADAPTOR	AD-4914N,EOS17,100-240VAC,47 - 63 HZ,+14VDC,3.5A,-,49W,-,0 TO +40 C,120*63*31,SA	
BN91-00394A	-	ASSY CHASSIS	MB15NO	
BN94-00309A	-	ASSY PCB MAIN	MB15NO	SNA
0201-001223	CIS	ADHESIVE-TS	HT-130S,RED,700+/- 50,-	SNA
0202-001044	CIS	SOLDER-WIRE	S63S-W3.0,S63S,D3,63Sn/37Pb,-	SNA
0202-001046	CIS	SOLDER-WIRE FLUX	CF-110VH-2A,-,-,-,-	SNA
0202-001222	CIS	SOLDER-WIRE FLUX	RS-107,RS60-1.2AA,D1.2,SN60/PB40,-	SNA
0204-001095	CIS	THINNER	#4520,-,-,-	SNA
BH73-60304E	CIS	RUBBER-SUPPORT	M015PS,CR V0,6*6*6.4,BLACK	SNA
BN39-00161B	CIS	LEAD CONNECTOR-ASSY	MB15UO,UL1571#30,UL/CSA,12P,#28,12505HS-12,12505HS-12,BK,40MM,1571#30,SJ02-01-05	
BN39-00272A	CIS	LEAD CONNECTOR-ASSY	MB15UO,UL1571#28,UL/CSA,20P,#28,12507HS-20,12507HS-20,BK,50MM,1571#28,SJ01-01-40	
BN39-00275A	CIS	LEAD CONNECTOR-ASSY	MB15UO,UL1061#28,UL/CSA,8P,#28,12505HS-08,12505HS-08,BK,125MM,1061#28,SJ02-01-06	
BN39-00287A	CIS	LEAD CONNECTOR-ASSY	MB15UO,UL1571#28,UL/CSA,21P,#28,FI-W21S,FI-W21S,BK,40MM,1571#28,SJ01-01-405(1)	
BN39-00288A	CIS	LEAD CONNECTOR-ASSY	MB15UO,UL1571#28,UL/CSA,31(25)P,#28,FI-W31S,FI-W31S,BK,40MM,1571#28,SJ01-01-405(
BN44-00061B	CIS	INVERTER	MB15UO,S1C540A,48KHZ,14VDC,3.6MARMs,6.8MARMs,48KHZ,140*65.5*7.0,4LAMP,48KHZ	
BN60-00011A	CIS	FASTENER-PEM/NUT	MINERVA,SUM24L(SN),M3,-,7.0,6.8,WHT	SNA
BN63-00174A	CIS	COVER-PCB	RB15,ABS,-,-,-,V0,-,IV16,TBBA,1.5	SNA
BN63-00345A	CIS	SHIELD-SUB	M015,SUS,TO.15	SNA
BN63-00413A	CIS	GASKET	MB15KO,CONDUCTIVE FABRIC,5MM,8MM,8MM,GRAY,71TSMK 8-5-8-13-D,71TSMK 8-5-8-13-D	SNA
BN97-00096M	-	ASSY MICOM	MB15NO	
1102-001129	IC620	IC-EPROM	M27W401,512KX8BIT,PLCC,32P,11.35X13.89MM,80NS,3.3V,10%,PLASTIC,-40TO+85C,-,CMOS,	
BN46-00012J	CIS	S/W MICOM	MB15NO	SNA
BN97-00100A	-	ASSY SMD	MB15NO	SNA
0202-001162	CIS	SOLDER-CREAM	RMA-20-21L,S63,-,SN63/PB36.6/AGO.4,FLUX9.5%	SNA
0401-001056	D409	DIODE-SWITCHING	MMD4148SE,75V,200MA,SOT-23,TP	

0401-001056	D410	DIODE-SWITCHING	MMBD4148SE,75V,200MA,SOT-23,TP
0401-001056	D411	DIODE-SWITCHING	MMBD4148SE,75V,200MA,SOT-23,TP
0401-001056	D681	DIODE-SWITCHING	MMBD4148SE,75V,200MA,SOT-23,TP
0401-001056	D804	DIODE-SWITCHING	MMBD4148SE,75V,200MA,SOT-23,TP
0402-000553	D802	DIODE-RECTIFIER	SS24,40V,2.0A,DO-214AA
0402-000553	D875	DIODE-RECTIFIER	SS24,40V,2.0A,DO-214AA
0402-001098	D803	DIODE-RECTIFIER	SK34,40V,3A,SMC,TP
0403-000579	D601	DIODE-ZENER	BZX84C5V1,5.1V,5%,200mW,SOT-23
0403-000579	D602	DIODE-ZENER	BZX84C5V1,5.1V,5%,200mW,SOT-23
0403-000579	D604	DIODE-ZENER	BZX84C5V1,5.1V,5%,200mW,SOT-23
0403-001052	D543	DIODE-ZENER	RD8.2MB,8.2V,7.7-8.64V,200mW,S
0403-001052	D545	DIODE-ZENER	RD8.2MB,8.2V,7.7-8.64V,200mW,S
0403-001052	D876	DIODE-ZENER	RD8.2MB,8.2V,7.7-8.64V,200mW,S
0403-001052	D877	DIODE-ZENER	RD8.2MB,8.2V,7.7-8.64V,200mW,S
0404-001166	D805	DIODE-SCHOTTKY	MBRM130LT3,30V,1000MA,DO-216AA,TP
0404-001166	D806	DIODE-SCHOTTKY	MBRM130LT3,30V,1000MA,DO-216AA,TP
0501-000342	Q01	TR-SMALL SIGNAL	KSC1623-Y,NPN,200mW,SOT-23,TP,135-270
0501-000342	Q611	TR-SMALL SIGNAL	KSC1623-Y,NPN,200mW,SOT-23,TP,135-270
0501-002080	Q601	TR-SMALL SIGNAL	2SC2412K,NPN,200mW,SC-59,TP,120-270
0501-002080	Q610	TR-SMALL SIGNAL	2SC2412K,NPN,200mW,SC-59,TP,120-270
0501-002080	Q808	TR-SMALL SIGNAL	2SC2412K,NPN,200mW,SC-59,TP,120-270
0501-002080	Q809	TR-SMALL SIGNAL	2SC2412K,NPN,200mW,SC-59,TP,120-270
0501-002080	Q810	TR-SMALL SIGNAL	2SC2412K,NPN,200mW,SC-59,TP,120-270
0501-002080	Q811	TR-SMALL SIGNAL	2SC2412K,NPN,200mW,SC-59,TP,120-270
0501-002080	Q812	TR-SMALL SIGNAL	2SC2412K,NPN,200mW,SC-59,TP,120-270
0505-001170	IC808	FET-SILICON	SI9933ADY-T1,P,-20V,3.4A,0.06ohm,2W,SO-8
0801-002267	IC406	IC-CMOS LOGIC	74LCX14,-,SOIC,14P,150MIL,-,TP,-,-,3.6V,-40TO+85C,-,5.5V,-,-,24MA
0801-002547	IC408	IC-CMOS LOGIC	74VHC157,MULTIPLEXER,SOP,16P,150MIL,QUAD,TP,PLASTIC,-,-,0.36V,-40to+85C,-,1.5V,4
0904-001009	IC631	IC-I/O SUPPORT CHIP	8574A,-,SOP,16P,300MIL,100KHz,
0904-001009	IC632	IC-I/O SUPPORT CHIP	8574A,-,SOP,16P,300MIL,100KHz,
1001-001082	IC403	IC-VIDEO SWITCH	BA7657F,-,SOP,24P,300MIL,SINGL
1001-001109	IC681	IC-ANALOG SWITCH	FST3125M,BUS SWITCH & CMOS,SOIC,17P,150MIL,QUAD,7V,-40TO+85C,PLASTIC,-,4.00HM,5.
1002-001292	IC350	IC-A/D CONVERTER	AD9883AKST-110,8BITS,QFP,80P,551MIL,±0.5LSB,TR,CMOS,PLASTIC,3.3V,-25TO+85C,650M
1003-001419	IC300	IC-DISPLAY DRIVER	MN82860,QFP,208P,1102MIL,-,-,TR,PLASTIC,3.3V,-,2.3W,-,-
1103-000129	IC401	IC-EEPROM	24C02,256x8BIT,SOP,8P,150MIL,1
1103-000138	IC603	IC-EEPROM	24C16,2Kx8BIT,SOP,8P,150MIL,10
1109-001209	IC210	IC-GRAM	M32L32321SA,2X512KX32BIT,QFP,100P,-,7NS,3.3V,10%,PLASTIC,-55TO+150C,2MA,CMOS,TR
1109-001209	IC211	IC-GRAM	M32L32321SA,2X512KX32BIT,QFP,100P,-,7NS,3.3V,10%,PLASTIC,-55TO+150C,2MA,CMOS,TR
1201-001559	IC503	IC-AUDIO AMP	4863,TSSOP,20P,173MIL,DUAL,98dB,PLASTIC,5.5V,2.45W,-40to+85C,-,-,-,-
1203-000404	IC811	IC-DC/DC CONVERTER	34063,SOP,8P,150MIL,PLASTIC,1.0/1.3V,-,0TO+70C,4.0MA,-,ST
1203-000404	IC812	IC-DC/DC CONVERTER	34063,SOP,8P,150MIL,PLASTIC,1.0/1.3V,-,0TO+70C,4.0MA,-,ST
1203-001212	IC604	IC-VOL. DETECTOR	7029,SOT-89,3P,-,PLASTIC,-,500
1203-001293	IC301	IC-POSITIVE FIXED REG.	033,TO-252,3P,6.5MIL,PLASTIC,3
1203-001293	IC813	IC-POSITIVE FIXED REG.	033,TO-252,3P,6.5MIL,PLASTIC,3
1203-001448	IC804	IC-SWITCH VOL. REG.	2596,TO-263,5P,-,PLASTIC,4.750
1203-001448	IC807	IC-SWITCH VOL. REG.	2596,TO-263,5P,-,PLASTIC,4.750
1203-001816	IC803	IC-POSITIVE FIXED REG.	78M08,TO-252,3P,-,PLASTIC,7.7/8.3V,1.0W,-40TO+85C,0.5A,-,TP
1203-001830	IC805	IC-SWITCH VOL. REG.	2676,TO-263,7P,-,PLASTIC,3.234/3.336V,-,-40TO+125C,3A,-,TP
1203-001890	IC802	IC-VOLTAGE REGULATOR	3961,SOT223-5,5P,-,PLASTIC,2.5V,-,-40to+125C,800mA,-,TR
1203-001890	IC806	IC-VOLTAGE REGULATOR	3961,SOT223-5,5P,-,PLASTIC,2.5V,-,-40to+125C,800mA,-,TR
1204-001551	IC175	IC-VIDEO SYSTEM	GS1881,SOIC,8P,150MIL,PLASTIC,13.2V,-,0TO+70C,TP,VIDEO SYNC SEPARATOR
1204-001852	IC919	IC-SOUND PROCESSOR	MSP3421G-B8,PQFP,80P,-,PLASTIC,9V,1000MW,0TO70C,TR,-
1204-001911	IC200	IC-VIDEO PROCESS	DPTV-3D-6730,PQFP,208P,28X28MM,PLASTIC,4.6V,-,0TO+70C,TR,-
1204-001912	IC601	IC-DECODER	SDA5550M,P-MQFP,100P,-,PLASTIC,3.3V,1.5W,0TO+70C,TR,-
1205-001740	IC901	IC-TRANSMITTER	DS90C385,TSSOP,56P,240MIL,PLASTIC,4V,1.63W,-10 TO +70C,ST,FPD LINK-85MHZ(LVDS)
1206-000111	ICA5	IC-TIMER	KA555D/T.R,SOP,8P,150MIL,-,18V
2007-000052	R4564	R-CHIP	10Kohm,1%,1/16W,DA,TP,1608
2007-000052	R4565	R-CHIP	10Kohm,1%,1/16W,DA,TP,1608
2007-000052	R4566	R-CHIP	10Kohm,1%,1/16W,DA,TP,1608

2007-000074	R637	R-CHIP	100ohm,5%,1/16W,DA,TP,1608
2007-000074	R643	R-CHIP	100ohm,5%,1/16W,DA,TP,1608
2007-000074	R644	R-CHIP	100ohm,5%,1/16W,DA,TP,1608
2007-000074	R650	R-CHIP	100ohm,5%,1/16W,DA,TP,1608
2007-000074	R652	R-CHIP	100ohm,5%,1/16W,DA,TP,1608
2007-000074	R662	R-CHIP	100ohm,5%,1/16W,DA,TP,1608
2007-000074	R663	R-CHIP	100ohm,5%,1/16W,DA,TP,1608
2007-000074	R664	R-CHIP	100ohm,5%,1/16W,DA,TP,1608
2007-000074	R667	R-CHIP	100ohm,5%,1/16W,DA,TP,1608
2007-000074	R670	R-CHIP	100ohm,5%,1/16W,DA,TP,1608
2007-000074	R683	R-CHIP	100ohm,5%,1/16W,DA,TP,1608
2007-000074	R685	R-CHIP	100ohm,5%,1/16W,DA,TP,1608
2007-000074	R686	R-CHIP	100ohm,5%,1/16W,DA,TP,1608
2007-000074	R687	R-CHIP	100ohm,5%,1/16W,DA,TP,1608
2007-000074	RA1	R-CHIP	100ohm,5%,1/16W,DA,TP,1608
2007-000074	RA2	R-CHIP	100ohm,5%,1/16W,DA,TP,1608
2007-000075	R639	R-CHIP	220ohm,5%,1/16W,DA,TP,1608
2007-000075	R642	R-CHIP	220ohm,5%,1/16W,DA,TP,1608
2007-000075	R651	R-CHIP	220ohm,5%,1/16W,DA,TP,1608
2007-000075	R680	R-CHIP	220ohm,5%,1/16W,DA,TP,1608
2007-000075	R682	R-CHIP	220ohm,5%,1/16W,DA,TP,1608
2007-000075	RA3	R-CHIP	220ohm,5%,1/16W,DA,TP,1608
2007-000076	R665	R-CHIP	330ohm,5%,1/16W,DA,TP,1608
2007-000076	R666	R-CHIP	330ohm,5%,1/16W,DA,TP,1608
2007-000076	R668	R-CHIP	330ohm,5%,1/16W,DA,TP,1608
2007-000076	R671	R-CHIP	330ohm,5%,1/16W,DA,TP,1608
2007-000076	R672	R-CHIP	330ohm,5%,1/16W,DA,TP,1608
2007-000076	R673	R-CHIP	330ohm,5%,1/16W,DA,TP,1608
2007-000077	R4005	R-CHIP	470ohm,5%,1/16W,DA,TP,1608
2007-000077	R4009	R-CHIP	470ohm,5%,1/16W,DA,TP,1608
2007-000077	R623	R-CHIP	470ohm,5%,1/16W,DA,TP,1608
2007-000078	R505	R-CHIP	1Kohm,5%,1/16W,DA,TP,1608
2007-000078	R506	R-CHIP	1Kohm,5%,1/16W,DA,TP,1608
2007-000078	R509	R-CHIP	1Kohm,5%,1/16W,DA,TP,1608
2007-000078	R510	R-CHIP	1Kohm,5%,1/16W,DA,TP,1608
2007-000078	R516	R-CHIP	1Kohm,5%,1/16W,DA,TP,1608
2007-000078	R517	R-CHIP	1Kohm,5%,1/16W,DA,TP,1608
2007-000078	R520	R-CHIP	1Kohm,5%,1/16W,DA,TP,1608
2007-000078	R521	R-CHIP	1Kohm,5%,1/16W,DA,TP,1608
2007-000078	R522	R-CHIP	1Kohm,5%,1/16W,DA,TP,1608
2007-000078	R529	R-CHIP	1Kohm,5%,1/16W,DA,TP,1608
2007-000078	R531	R-CHIP	1Kohm,5%,1/16W,DA,TP,1608
2007-000078	R604	R-CHIP	1Kohm,5%,1/16W,DA,TP,1608
2007-000080	R807	R-CHIP	2Kohm,5%,1/16W,DA,TP,1608
2007-000082	R356	R-CHIP	3.3Kohm,5%,1/16W,DA,TP,1608
2007-000082	R4006	R-CHIP	3.3Kohm,5%,1/16W,DA,TP,1608
2007-000082	R4010	R-CHIP	3.3Kohm,5%,1/16W,DA,TP,1608
2007-000082	R4551	R-CHIP	3.3Kohm,5%,1/16W,DA,TP,1608
2007-000084	R02	R-CHIP	4.7Kohm,5%,1/16W,DA,TP,1608
2007-000084	R239	R-CHIP	4.7Kohm,5%,1/16W,DA,TP,1608
2007-000084	R302	R-CHIP	4.7Kohm,5%,1/16W,DA,TP,1608
2007-000084	R527	R-CHIP	4.7Kohm,5%,1/16W,DA,TP,1608
2007-000084	R617	R-CHIP	4.7Kohm,5%,1/16W,DA,TP,1608
2007-000084	R631	R-CHIP	4.7Kohm,5%,1/16W,DA,TP,1608
2007-000084	R636	R-CHIP	4.7Kohm,5%,1/16W,DA,TP,1608
2007-000084	R646	R-CHIP	4.7Kohm,5%,1/16W,DA,TP,1608
2007-000084	R648	R-CHIP	4.7Kohm,5%,1/16W,DA,TP,1608
2007-000084	R649	R-CHIP	4.7Kohm,5%,1/16W,DA,TP,1608
2007-000084	R674	R-CHIP	4.7Kohm,5%,1/16W,DA,TP,1608

2007-000084	R675	R-CHIP	4.7Kohm, 5%, 1/16W, DA, TP, 1608
2007-000084	R821	R-CHIP	4.7Kohm, 5%, 1/16W, DA, TP, 1608
2007-000084	R822	R-CHIP	4.7Kohm, 5%, 1/16W, DA, TP, 1608
2007-000084	R841	R-CHIP	4.7Kohm, 5%, 1/16W, DA, TP, 1608
2007-000084	R842	R-CHIP	4.7Kohm, 5%, 1/16W, DA, TP, 1608
2007-000084	R891	R-CHIP	4.7Kohm, 5%, 1/16W, DA, TP, 1608
2007-000090	R208	R-CHIP	10KOHM, 5%, 1/16W, DA, TP, 1608
2007-000090	R241	R-CHIP	10KOHM, 5%, 1/16W, DA, TP, 1608
2007-000090	R248	R-CHIP	10KOHM, 5%, 1/16W, DA, TP, 1608
2007-000090	R301	R-CHIP	10KOHM, 5%, 1/16W, DA, TP, 1608
2007-000090	R327	R-CHIP	10KOHM, 5%, 1/16W, DA, TP, 1608
2007-000090	R357	R-CHIP	10KOHM, 5%, 1/16W, DA, TP, 1608
2007-000090	R358	R-CHIP	10KOHM, 5%, 1/16W, DA, TP, 1608
2007-000090	R601	R-CHIP	10KOHM, 5%, 1/16W, DA, TP, 1608
2007-000090	R607	R-CHIP	10KOHM, 5%, 1/16W, DA, TP, 1608
2007-000090	R609	R-CHIP	10KOHM, 5%, 1/16W, DA, TP, 1608
2007-000090	R621	R-CHIP	10KOHM, 5%, 1/16W, DA, TP, 1608
2007-000090	R622	R-CHIP	10KOHM, 5%, 1/16W, DA, TP, 1608
2007-000090	R653	R-CHIP	10KOHM, 5%, 1/16W, DA, TP, 1608
2007-000090	R654	R-CHIP	10KOHM, 5%, 1/16W, DA, TP, 1608
2007-000090	R655	R-CHIP	10KOHM, 5%, 1/16W, DA, TP, 1608
2007-000090	R656	R-CHIP	10KOHM, 5%, 1/16W, DA, TP, 1608
2007-000090	R657	R-CHIP	10KOHM, 5%, 1/16W, DA, TP, 1608
2007-000090	R658	R-CHIP	10KOHM, 5%, 1/16W, DA, TP, 1608
2007-000090	R659	R-CHIP	10KOHM, 5%, 1/16W, DA, TP, 1608
2007-000090	R661	R-CHIP	10KOHM, 5%, 1/16W, DA, TP, 1608
2007-000090	R676	R-CHIP	10KOHM, 5%, 1/16W, DA, TP, 1608
2007-000090	R677	R-CHIP	10KOHM, 5%, 1/16W, DA, TP, 1608
2007-000090	R678	R-CHIP	10KOHM, 5%, 1/16W, DA, TP, 1608
2007-000090	R684	R-CHIP	10KOHM, 5%, 1/16W, DA, TP, 1608
2007-000090	R823	R-CHIP	10KOHM, 5%, 1/16W, DA, TP, 1608
2007-000090	R824	R-CHIP	10KOHM, 5%, 1/16W, DA, TP, 1608
2007-000090	R873	R-CHIP	10KOHM, 5%, 1/16W, DA, TP, 1608
2007-000091	R4560	R-CHIP	12Kohm, 5%, 1/16W, DA, TP, 1608
2007-000091	R4561	R-CHIP	12Kohm, 5%, 1/16W, DA, TP, 1608
2007-000091	R4562	R-CHIP	12Kohm, 5%, 1/16W, DA, TP, 1608
2007-000091	R4563	R-CHIP	12Kohm, 5%, 1/16W, DA, TP, 1608
2007-000092	R4568	R-CHIP	15Kohm, 5%, 1/16W, DA, TP, 1608
2007-000092	R4569	R-CHIP	15Kohm, 5%, 1/16W, DA, TP, 1608
2007-000093	R312	R-CHIP	20Kohm, 5%, 1/16W, DA, TP, 1608
2007-000097	R608	R-CHIP	47Kohm, 5%, 1/16W, DA, TP, 1608
2007-000098	R690	R-CHIP	56Kohm, 5%, 1/16W, DA, TP, 1608
2007-000102	R553	R-CHIP	100Kohm, 5%, 1/16W, DA, TP, 1608
2007-000102	R554	R-CHIP	100Kohm, 5%, 1/16W, DA, TP, 1608
2007-000102	R874	R-CHIP	100Kohm, 5%, 1/16W, DA, TP, 1608
2007-000107	R404	R-CHIP	470Kohm, 5%, 1/16W, DA, TP, 1608
2007-000109	R305	R-CHIP	1Mohm, 5%, 1/16W, DA, TP, 1608
2007-000109	R309	R-CHIP	1Mohm, 5%, 1/16W, DA, TP, 1608
2007-000109	R317	R-CHIP	1Mohm, 5%, 1/16W, DA, TP, 1608
2007-000113	R201	R-CHIP	33ohm, 5%, 1/16W, DA, TP, 1608
2007-000113	R202	R-CHIP	33ohm, 5%, 1/16W, DA, TP, 1608
2007-000113	R203	R-CHIP	33ohm, 5%, 1/16W, DA, TP, 1608
2007-000113	R204	R-CHIP	33ohm, 5%, 1/16W, DA, TP, 1608
2007-000113	R205	R-CHIP	33ohm, 5%, 1/16W, DA, TP, 1608
2007-000113	R206	R-CHIP	33ohm, 5%, 1/16W, DA, TP, 1608
2007-000113	R207	R-CHIP	33ohm, 5%, 1/16W, DA, TP, 1608
2007-000113	R219	R-CHIP	33ohm, 5%, 1/16W, DA, TP, 1608
2007-000116	R238	R-CHIP	120ohm, 5%, 1/16W, DA, TP, 1608
2007-000116	R4007	R-CHIP	120ohm, 5%, 1/16W, DA, TP, 1608

2007-000116	R906	R-CHIP	120ohm,5%,1/16W,DA,TP,1608
2007-000118	R235	R-CHIP	390ohm,5%,1/16W,DA,TP,1608
2007-000119	R4556	R-CHIP	560ohm,5%,1/16W,DA,TP,1608
2007-000119	R4557	R-CHIP	560ohm,5%,1/16W,DA,TP,1608
2007-000119	R4558	R-CHIP	560ohm,5%,1/16W,DA,TP,1608
2007-000119	R4559	R-CHIP	560ohm,5%,1/16W,DA,TP,1608
2007-000120	R645	R-CHIP	680ohm,5%,1/16W,DA,TP,1608
2007-000123	R01	R-CHIP	1.5Kohm,5%,1/16W,DA,TP,1608
2007-000124	R944	R-CHIP	2.2Kohm,5%,1/16W,DA,TP,1608
2007-000134	R511	R-CHIP	33Kohm,5%,1/16W,DA,TP,1608
2007-000134	R539	R-CHIP	33Kohm,5%,1/16W,DA,TP,1608
2007-000219	R806	R-CHIP	1.2Kohm,1%,1/16W,DA,TP,1608
2007-000219	R809	R-CHIP	1.2Kohm,1%,1/16W,DA,TP,1608
2007-000239	R612	R-CHIP	1.5Kohm,1%,1/16W,DA,TP,1608
2007-000239	R613	R-CHIP	1.5Kohm,1%,1/16W,DA,TP,1608
2007-000309	R214	R-CHIP	10ohm,5%,1/16W,DA,TP,1608
2007-000309	R215	R-CHIP	10ohm,5%,1/16W,DA,TP,1608
2007-000309	R224	R-CHIP	10ohm,5%,1/16W,DA,TP,1608
2007-000309	R692	R-CHIP	10ohm,5%,1/16W,DA,TP,1608
2007-000309	R693	R-CHIP	10ohm,5%,1/16W,DA,TP,1608
2007-000309	RJ15	R-CHIP	10ohm,5%,1/16W,DA,TP,1608
2007-000309	RJ16	R-CHIP	10ohm,5%,1/16W,DA,TP,1608
2007-000309	RJ17	R-CHIP	10ohm,5%,1/16W,DA,TP,1608
2007-000402	R610	R-CHIP	150ohm,5%,1/16W,DA,TP,1608
2007-000402	R611	R-CHIP	150ohm,5%,1/16W,DA,TP,1608
2007-000402	R620	R-CHIP	150ohm,5%,1/16W,DA,TP,1608
2007-000402	R943	R-CHIP	150ohm,5%,1/16W,DA,TP,1608
2007-000616	R318	R-CHIP	24Kohm,5%,1/16W,DA,TP,1608
2007-000701	R810	R-CHIP	3.6Kohm,1%,1/16W,DA,TP,1608
2007-000882	R4571	R-CHIP	4.7ohm,5%,1/16W,DA,TP,1608
2007-000882	R4572	R-CHIP	4.7ohm,5%,1/16W,DA,TP,1608
2007-001039	R602	R-CHIP	56KOHM,5%,1/10W,DA,TP,2012
2007-001114	R4008	R-CHIP	680Kohm,5%,1/16W,DA,TP,1608
2007-001164	R307	R-CHIP	75ohm,1%,1/16W,DA,TP,1608
2007-001164	R308	R-CHIP	75ohm,1%,1/16W,DA,TP,1608
2007-001164	R310	R-CHIP	75ohm,1%,1/16W,DA,TP,1608
2007-001164	R311	R-CHIP	75ohm,1%,1/16W,DA,TP,1608
2007-001164	R313	R-CHIP	75ohm,1%,1/16W,DA,TP,1608
2007-001164	R319	R-CHIP	75ohm,1%,1/16W,DA,TP,1608
2007-001167	R236	R-CHIP	75ohm,5%,1/16W,DA,TP,1608
2007-001167	R401	R-CHIP	75ohm,5%,1/16W,DA,TP,1608
2007-001167	R402	R-CHIP	75ohm,5%,1/16W,DA,TP,1608
2007-001167	R403	R-CHIP	75ohm,5%,1/16W,DA,TP,1608
2007-001167	R619	R-CHIP	75ohm,5%,1/16W,DA,TP,1608
2007-008433	R4570	R-CHIP	0.330HM,1%,1W,DA,TP,6432
2007-008433	R805	R-CHIP	0.330HM,1%,1W,DA,TP,6432
2007-008433	R808	R-CHIP	0.330HM,1%,1W,DA,TP,6432
2011-000002	RA301	R-NETWORK	22ohm,5%,63mW,L,CHIP,8P,TP
2011-000002	RA302	R-NETWORK	22ohm,5%,63mW,L,CHIP,8P,TP
2011-000002	RA303	R-NETWORK	22ohm,5%,63mW,L,CHIP,8P,TP
2011-000002	RA304	R-NETWORK	22ohm,5%,63mW,L,CHIP,8P,TP
2011-000002	RA305	R-NETWORK	22ohm,5%,63mW,L,CHIP,8P,TP
2011-000002	RA306	R-NETWORK	22ohm,5%,63mW,L,CHIP,8P,TP
2011-000515	RA610	R-NETWORK	4.7Kohm,5%,1/16W,L,CHIP,8P,TP
2011-000515	RA611	R-NETWORK	4.7Kohm,5%,1/16W,L,CHIP,8P,TP
2011-000651	RA601	R-NETWORK	10ohm,5%,63mW,L,CHIP,8P,TP
2011-000651	RA602	R-NETWORK	10ohm,5%,63mW,L,CHIP,8P,TP
2011-000651	RA603	R-NETWORK	10ohm,5%,63mW,L,CHIP,8P,TP
2011-000651	RA604	R-NETWORK	10ohm,5%,63mW,L,CHIP,8P,TP

2011-000651	RA605	R-NETWORK	10ohm, 5%, 63mW, L, CHIP, 8P, TP
2011-000651	RA606	R-NETWORK	10ohm, 5%, 63mW, L, CHIP, 8P, TP
2011-000651	RA607	R-NETWORK	10ohm, 5%, 63mW, L, CHIP, 8P, TP
2011-000651	RA608	R-NETWORK	10ohm, 5%, 63mW, L, CHIP, 8P, TP
2011-000651	RA609	R-NETWORK	10ohm, 5%, 63mW, L, CHIP, 8P, TP
2203-000140	C538	C-CERAMIC, CHIP	1.5nF, 10%, 50V, X7R, TP, 1608, -
2203-000140	C574	C-CERAMIC, CHIP	1.5nF, 10%, 50V, X7R, TP, 1608, -
2203-000189	C338	C-CERAMIC, CHIP	100nF, +80-20%, 25V, Y5V, TP, 1608,
2203-000189	C3503	C-CERAMIC, CHIP	100nF, +80-20%, 25V, Y5V, TP, 1608,
2203-000189	C559	C-CERAMIC, CHIP	100nF, +80-20%, 25V, Y5V, TP, 1608,
2203-000189	C565	C-CERAMIC, CHIP	100nF, +80-20%, 25V, Y5V, TP, 1608,
2203-000189	C620	C-CERAMIC, CHIP	100nF, +80-20%, 25V, Y5V, TP, 1608,
2203-000189	C624	C-CERAMIC, CHIP	100nF, +80-20%, 25V, Y5V, TP, 1608,
2203-000189	C844	C-CERAMIC, CHIP	100nF, +80-20%, 25V, Y5V, TP, 1608,
2203-000189	C846	C-CERAMIC, CHIP	100nF, +80-20%, 25V, Y5V, TP, 1608,
2203-000189	C849	C-CERAMIC, CHIP	100nF, +80-20%, 25V, Y5V, TP, 1608,
2203-000189	C852	C-CERAMIC, CHIP	100nF, +80-20%, 25V, Y5V, TP, 1608,
2203-000189	C853	C-CERAMIC, CHIP	100nF, +80-20%, 25V, Y5V, TP, 1608,
2203-000189	C856	C-CERAMIC, CHIP	100nF, +80-20%, 25V, Y5V, TP, 1608,
2203-000189	C858	C-CERAMIC, CHIP	100nF, +80-20%, 25V, Y5V, TP, 1608,
2203-000189	C862	C-CERAMIC, CHIP	100nF, +80-20%, 25V, Y5V, TP, 1608,
2203-000189	C864	C-CERAMIC, CHIP	100nF, +80-20%, 25V, Y5V, TP, 1608,
2203-000189	C868	C-CERAMIC, CHIP	100nF, +80-20%, 25V, Y5V, TP, 1608,
2203-000189	C871	C-CERAMIC, CHIP	100nF, +80-20%, 25V, Y5V, TP, 1608,
2203-000189	C872	C-CERAMIC, CHIP	100nF, +80-20%, 25V, Y5V, TP, 1608,
2203-000189	C881	C-CERAMIC, CHIP	100nF, +80-20%, 25V, Y5V, TP, 1608,
2203-000189	C882	C-CERAMIC, CHIP	100nF, +80-20%, 25V, Y5V, TP, 1608,
2203-000189	C883	C-CERAMIC, CHIP	100nF, +80-20%, 25V, Y5V, TP, 1608,
2203-000189	C893	C-CERAMIC, CHIP	100nF, +80-20%, 25V, Y5V, TP, 1608,
2203-000189	C908	C-CERAMIC, CHIP	100nF, +80-20%, 25V, Y5V, TP, 1608,
2203-000189	C9576	C-CERAMIC, CHIP	100nF, +80-20%, 25V, Y5V, TP, 1608,
2203-000189	C9577	C-CERAMIC, CHIP	100nF, +80-20%, 25V, Y5V, TP, 1608,
2203-000189	C9578	C-CERAMIC, CHIP	100nF, +80-20%, 25V, Y5V, TP, 1608,
2203-000189	CA1	C-CERAMIC, CHIP	100nF, +80-20%, 25V, Y5V, TP, 1608,
2203-000189	U123	C-CERAMIC, CHIP	100nF, +80-20%, 25V, Y5V, TP, 1608,
2203-000236	C219	C-CERAMIC, CHIP	0.1nF, 5%, 50V, NPO, TP, 1608
2203-000236	C222	C-CERAMIC, CHIP	0.1nF, 5%, 50V, NPO, TP, 1608
2203-000236	C227	C-CERAMIC, CHIP	0.1nF, 5%, 50V, NPO, TP, 1608
2203-000236	C228	C-CERAMIC, CHIP	0.1nF, 5%, 50V, NPO, TP, 1608
2203-000236	C232	C-CERAMIC, CHIP	0.1nF, 5%, 50V, NPO, TP, 1608
2203-000236	C233	C-CERAMIC, CHIP	0.1nF, 5%, 50V, NPO, TP, 1608
2203-000236	C234	C-CERAMIC, CHIP	0.1nF, 5%, 50V, NPO, TP, 1608
2203-000236	C235	C-CERAMIC, CHIP	0.1nF, 5%, 50V, NPO, TP, 1608
2203-000236	C237	C-CERAMIC, CHIP	0.1nF, 5%, 50V, NPO, TP, 1608
2203-000236	C239	C-CERAMIC, CHIP	0.1nF, 5%, 50V, NPO, TP, 1608
2203-000236	C242	C-CERAMIC, CHIP	0.1nF, 5%, 50V, NPO, TP, 1608
2203-000236	C246	C-CERAMIC, CHIP	0.1nF, 5%, 50V, NPO, TP, 1608
2203-000236	C248	C-CERAMIC, CHIP	0.1nF, 5%, 50V, NPO, TP, 1608
2203-000236	C257	C-CERAMIC, CHIP	0.1nF, 5%, 50V, NPO, TP, 1608
2203-000236	C259	C-CERAMIC, CHIP	0.1nF, 5%, 50V, NPO, TP, 1608
2203-000236	C268	C-CERAMIC, CHIP	0.1nF, 5%, 50V, NPO, TP, 1608
2203-000236	C271	C-CERAMIC, CHIP	0.1nF, 5%, 50V, NPO, TP, 1608
2203-000236	C476	C-CERAMIC, CHIP	0.1nF, 5%, 50V, NPO, TP, 1608
2203-000236	C477	C-CERAMIC, CHIP	0.1nF, 5%, 50V, NPO, TP, 1608
2203-000236	C617	C-CERAMIC, CHIP	0.1nF, 5%, 50V, NPO, TP, 1608
2203-000236	C9581	C-CERAMIC, CHIP	0.1nF, 5%, 50V, NPO, TP, 1608
2203-000257	C3401	C-CERAMIC, CHIP	10nF, 10%, 50V, X7R, TP, 1608
2203-000257	C383	C-CERAMIC, CHIP	10nF, 10%, 50V, X7R, TP, 1608
2203-000257	C412	C-CERAMIC, CHIP	10nF, 10%, 50V, X7R, TP, 1608

2203-000257	C498	C-CERAMIC,CHIP	10nF,10%,50V,X7R,TP,1608
2203-000257	C623	C-CERAMIC,CHIP	10nF,10%,50V,X7R,TP,1608
2203-000257	C859	C-CERAMIC,CHIP	10nF,10%,50V,X7R,TP,1608
2203-000257	C863	C-CERAMIC,CHIP	10nF,10%,50V,X7R,TP,1608
2203-000257	C866	C-CERAMIC,CHIP	10nF,10%,50V,X7R,TP,1608
2203-000257	C921	C-CERAMIC,CHIP	10nF,10%,50V,X7R,TP,1608
2203-000257	C9566	C-CERAMIC,CHIP	10nF,10%,50V,X7R,TP,1608
2203-000257	C9568	C-CERAMIC,CHIP	10nF,10%,50V,X7R,TP,1608
2203-000257	C9584	C-CERAMIC,CHIP	10nF,10%,50V,X7R,TP,1608
2203-000257	C9593	C-CERAMIC,CHIP	10nF,10%,50V,X7R,TP,1608
2203-000257	U122	C-CERAMIC,CHIP	10nF,10%,50V,X7R,TP,1608
2203-000260	C618	C-CERAMIC,CHIP	10nF,10%,50V,X7R,TP,2012
2203-000280	C527	C-CERAMIC,CHIP	0.01nF,0.5pF,50V,NP0,TP,1608
2203-000280	C572	C-CERAMIC,CHIP	0.01nF,0.5pF,50V,NP0,TP,1608
2203-000316	C814	C-CERAMIC,CHIP	0.12nF,5%,50V,NP0,TP,2012
2203-000316	C817	C-CERAMIC,CHIP	0.12nF,5%,50V,NP0,TP,2012
2203-000440	C301	C-CERAMIC,CHIP	1nF,10%,50V,X7R,TP,1608,-
2203-000440	C536	C-CERAMIC,CHIP	1nF,10%,50V,X7R,TP,1608,-
2203-000440	C537	C-CERAMIC,CHIP	1nF,10%,50V,X7R,TP,1608,-
2203-000440	C885	C-CERAMIC,CHIP	1nF,10%,50V,X7R,TP,1608,-
2203-000440	C901	C-CERAMIC,CHIP	1nF,10%,50V,X7R,TP,1608,-
2203-000440	C902	C-CERAMIC,CHIP	1nF,10%,50V,X7R,TP,1608,-
2203-000440	C905	C-CERAMIC,CHIP	1nF,10%,50V,X7R,TP,1608,-
2203-000440	C913	C-CERAMIC,CHIP	1nF,10%,50V,X7R,TP,1608,-
2203-000440	C914	C-CERAMIC,CHIP	1nF,10%,50V,X7R,TP,1608,-
2203-000440	C9569	C-CERAMIC,CHIP	1nF,10%,50V,X7R,TP,1608,-
2203-000440	C9570	C-CERAMIC,CHIP	1nF,10%,50V,X7R,TP,1608,-
2203-000440	C9571	C-CERAMIC,CHIP	1nF,10%,50V,X7R,TP,1608,-
2203-000552	C225	C-CERAMIC,CHIP	0.02nF,5%,50V,NP0,TP,1608
2203-000552	C226	C-CERAMIC,CHIP	0.02nF,5%,50V,NP0,TP,1608
2203-000552	C614	C-CERAMIC,CHIP	0.02nF,5%,50V,NP0,TP,1608
2203-000552	C615	C-CERAMIC,CHIP	0.02nF,5%,50V,NP0,TP,1608
2203-000626	C922	C-CERAMIC,CHIP	0.022nF,5%,50V,NP0,TP,1608
2203-000626	C923	C-CERAMIC,CHIP	0.022nF,5%,50V,NP0,TP,1608
2203-000626	C924	C-CERAMIC,CHIP	0.022nF,5%,50V,NP0,TP,1608
2203-000726	C381	C-CERAMIC,CHIP	3.9nF,10%,50V,X7R,TP,1608,-
2203-000815	C244	C-CERAMIC,CHIP	0.033nF,5%,50V,NP0,TP,1608
2203-000815	C290	C-CERAMIC,CHIP	0.033nF,5%,50V,NP0,TP,1608
2203-000815	C291	C-CERAMIC,CHIP	0.033nF,5%,50V,NP0,TP,1608
2203-000815	C292	C-CERAMIC,CHIP	0.033nF,5%,50V,NP0,TP,1608
2203-000815	C293	C-CERAMIC,CHIP	0.033nF,5%,50V,NP0,TP,1608
2203-000815	C294	C-CERAMIC,CHIP	0.033nF,5%,50V,NP0,TP,1608
2203-000815	C295	C-CERAMIC,CHIP	0.033nF,5%,50V,NP0,TP,1608
2203-000815	C296	C-CERAMIC,CHIP	0.033nF,5%,50V,NP0,TP,1608
2203-000815	C297	C-CERAMIC,CHIP	0.033nF,5%,50V,NP0,TP,1608
2203-000815	C298	C-CERAMIC,CHIP	0.033nF,5%,50V,NP0,TP,1608
2203-000815	C299	C-CERAMIC,CHIP	0.033nF,5%,50V,NP0,TP,1608
2203-000815	C304	C-CERAMIC,CHIP	0.033nF,5%,50V,NP0,TP,1608
2203-000815	C308	C-CERAMIC,CHIP	0.033nF,5%,50V,NP0,TP,1608
2203-000815	C309	C-CERAMIC,CHIP	0.033nF,5%,50V,NP0,TP,1608
2203-000815	C310	C-CERAMIC,CHIP	0.033nF,5%,50V,NP0,TP,1608
2203-000815	C312	C-CERAMIC,CHIP	0.033nF,5%,50V,NP0,TP,1608
2203-000815	C313	C-CERAMIC,CHIP	0.033nF,5%,50V,NP0,TP,1608
2203-000815	C314	C-CERAMIC,CHIP	0.033nF,5%,50V,NP0,TP,1608
2203-000815	C315	C-CERAMIC,CHIP	0.033nF,5%,50V,NP0,TP,1608
2203-000815	C316	C-CERAMIC,CHIP	0.033nF,5%,50V,NP0,TP,1608
2203-000815	C317	C-CERAMIC,CHIP	0.033nF,5%,50V,NP0,TP,1608
2203-000815	C320	C-CERAMIC,CHIP	0.033nF,5%,50V,NP0,TP,1608
2203-000815	C324	C-CERAMIC,CHIP	0.033nF,5%,50V,NP0,TP,1608

2203-000815	C325	C-CERAMIC,CHIP	0.033nF,5%,50V,NPO,TP,1608
2203-000815	C326	C-CERAMIC,CHIP	0.033nF,5%,50V,NPO,TP,1608
2203-000815	C330	C-CERAMIC,CHIP	0.033nF,5%,50V,NPO,TP,1608
2203-000815	C340	C-CERAMIC,CHIP	0.033nF,5%,50V,NPO,TP,1608
2203-000815	C366	C-CERAMIC,CHIP	0.033nF,5%,50V,NPO,TP,1608
2203-000815	C368	C-CERAMIC,CHIP	0.033nF,5%,50V,NPO,TP,1608
2203-000815	C371	C-CERAMIC,CHIP	0.033nF,5%,50V,NPO,TP,1608
2203-000815	C373	C-CERAMIC,CHIP	0.033nF,5%,50V,NPO,TP,1608
2203-000815	C375	C-CERAMIC,CHIP	0.033nF,5%,50V,NPO,TP,1608
2203-000815	C376	C-CERAMIC,CHIP	0.033nF,5%,50V,NPO,TP,1608
2203-000815	C454	C-CERAMIC,CHIP	0.033nF,5%,50V,NPO,TP,1608
2203-000815	C455	C-CERAMIC,CHIP	0.033nF,5%,50V,NPO,TP,1608
2203-000815	C456	C-CERAMIC,CHIP	0.033nF,5%,50V,NPO,TP,1608
2203-000815	C915	C-CERAMIC,CHIP	0.033nF,5%,50V,NPO,TP,1608
2203-000815	C9561	C-CERAMIC,CHIP	0.033nF,5%,50V,NPO,TP,1608
2203-000815	C9582	C-CERAMIC,CHIP	0.033nF,5%,50V,NPO,TP,1608
2203-000843	C379	C-CERAMIC,CHIP	39nF,10%,25V,X7R,TP,1608,-
2203-000972	C576	C-CERAMIC,CHIP	47nF,10%,16V,X7R,TP,1608
2203-000998	C306	C-CERAMIC,CHIP	0.047nF,5%,50V,NPO,TP,1608
2203-000998	C307	C-CERAMIC,CHIP	0.047nF,5%,50V,NPO,TP,1608
2203-000998	C3302	C-CERAMIC,CHIP	0.047nF,5%,50V,NPO,TP,1608
2203-001077	C567	C-CERAMIC,CHIP	0.056nF,5%,50V,NPO,TP,2012
2203-001077	C568	C-CERAMIC,CHIP	0.056nF,5%,50V,NPO,TP,2012
2203-001077	C571	C-CERAMIC,CHIP	0.056nF,5%,50V,NPO,TP,2012
2203-001077	C9572	C-CERAMIC,CHIP	0.056nF,5%,50V,NPO,TP,2012
2203-001077	C9573	C-CERAMIC,CHIP	0.056nF,5%,50V,NPO,TP,2012
2203-001077	C9574	C-CERAMIC,CHIP	0.056nF,5%,50V,NPO,TP,2012
2203-001077	C9575	C-CERAMIC,CHIP	0.056nF,5%,50V,NPO,TP,2012
2203-001607	C608	C-CERAMIC,CHIP	0.22nF,5%,50V,NPO,TP,1608
2203-001630	C9594	C-CERAMIC,CHIP	330nF,+80-20%,16V,Y5V,TP,1608
2203-001630	C9595	C-CERAMIC,CHIP	330nF,+80-20%,16V,Y5V,TP,1608
2203-001656	C404	C-CERAMIC,CHIP	0.47nF,5%,50V,NPO,TP,1608
2203-001656	C543	C-CERAMIC,CHIP	0.47nF,5%,50V,NPO,TP,1608
2203-001656	C569	C-CERAMIC,CHIP	0.47nF,5%,50V,NPO,TP,1608
2203-001656	C9564	C-CERAMIC,CHIP	0.47nF,5%,50V,NPO,TP,1608
2203-001656	C9565	C-CERAMIC,CHIP	0.47nF,5%,50V,NPO,TP,1608
2203-005005	C214	C-CERAMIC,CHIP	100nF,10%,16V,X7R,TP,1608
2203-005005	C215	C-CERAMIC,CHIP	100nF,10%,16V,X7R,TP,1608
2203-005005	C216	C-CERAMIC,CHIP	100nF,10%,16V,X7R,TP,1608
2203-005005	C217	C-CERAMIC,CHIP	100nF,10%,16V,X7R,TP,1608
2203-005005	C229	C-CERAMIC,CHIP	100nF,10%,16V,X7R,TP,1608
2203-005005	C238	C-CERAMIC,CHIP	100nF,10%,16V,X7R,TP,1608
2203-005005	C245	C-CERAMIC,CHIP	100nF,10%,16V,X7R,TP,1608
2203-005005	C249	C-CERAMIC,CHIP	100nF,10%,16V,X7R,TP,1608
2203-005005	C267	C-CERAMIC,CHIP	100nF,10%,16V,X7R,TP,1608
2203-005005	C274	C-CERAMIC,CHIP	100nF,10%,16V,X7R,TP,1608
2203-005005	C275	C-CERAMIC,CHIP	100nF,10%,16V,X7R,TP,1608
2203-005005	C276	C-CERAMIC,CHIP	100nF,10%,16V,X7R,TP,1608
2203-005005	C277	C-CERAMIC,CHIP	100nF,10%,16V,X7R,TP,1608
2203-005005	C278	C-CERAMIC,CHIP	100nF,10%,16V,X7R,TP,1608
2203-005005	C279	C-CERAMIC,CHIP	100nF,10%,16V,X7R,TP,1608
2203-005005	C282	C-CERAMIC,CHIP	100nF,10%,16V,X7R,TP,1608
2203-005005	C302	C-CERAMIC,CHIP	100nF,10%,16V,X7R,TP,1608
2203-005005	C303	C-CERAMIC,CHIP	100nF,10%,16V,X7R,TP,1608
2203-005005	C305	C-CERAMIC,CHIP	100nF,10%,16V,X7R,TP,1608
2203-005005	C318	C-CERAMIC,CHIP	100nF,10%,16V,X7R,TP,1608
2203-005005	C319	C-CERAMIC,CHIP	100nF,10%,16V,X7R,TP,1608
2203-005005	C321	C-CERAMIC,CHIP	100nF,10%,16V,X7R,TP,1608
2203-005005	C322	C-CERAMIC,CHIP	100nF,10%,16V,X7R,TP,1608

2402-000209	C284	C-AL, SMD	22uF, 20%, 16V, WT, TP, 5.3x5.3mm, 1
2402-000209	C285	C-AL, SMD	22uF, 20%, 16V, WT, TP, 5.3x5.3mm, 1
2402-000209	C903	C-AL, SMD	22uF, 20%, 16V, WT, TP, 5.3x5.3mm, 1
2402-000209	C916	C-AL, SMD	22uF, 20%, 16V, WT, TP, 5.3x5.3mm, 1
2402-000209	C9560	C-AL, SMD	22uF, 20%, 16V, WT, TP, 5.3x5.3mm, 1
2402-001018	C504	C-AL, SMD	470nF, 20%, 50V, GP, TP, 4.3x4.3x5.
2402-001018	C505	C-AL, SMD	470nF, 20%, 50V, GP, TP, 4.3x4.3x5.
2402-001019	C616	C-AL, SMD	2.2uF, 20%, 35V, GP, TP, 3.3x3.3x5.
2402-001042	C041	C-AL, SMD	100uF, 20%, 16V, GP, TP, 6.6x6.6x5.4mm
2402-001042	C247	C-AL, SMD	100uF, 20%, 16V, GP, TP, 6.6x6.6x5.4mm
2402-001042	C281	C-AL, SMD	100uF, 20%, 16V, GP, TP, 6.6x6.6x5.4mm
2402-001042	C336	C-AL, SMD	100uF, 20%, 16V, GP, TP, 6.6x6.6x5.4mm
2402-001042	C382	C-AL, SMD	100uF, 20%, 16V, GP, TP, 6.6x6.6x5.4mm
2402-001042	C392	C-AL, SMD	100uF, 20%, 16V, GP, TP, 6.6x6.6x5.4mm
2402-001042	C405	C-AL, SMD	100uF, 20%, 16V, GP, TP, 6.6x6.6x5.4mm
2402-001042	C535	C-AL, SMD	100uF, 20%, 16V, GP, TP, 6.6x6.6x5.4mm
2402-001042	C604	C-AL, SMD	100uF, 20%, 16V, GP, TP, 6.6x6.6x5.4mm
2402-001042	C621	C-AL, SMD	100uF, 20%, 16V, GP, TP, 6.6x6.6x5.4mm
2402-001042	C809	C-AL, SMD	100uF, 20%, 16V, GP, TP, 6.6x6.6x5.4mm
2402-001042	C847	C-AL, SMD	100uF, 20%, 16V, GP, TP, 6.6x6.6x5.4mm
2402-001042	C861	C-AL, SMD	100uF, 20%, 16V, GP, TP, 6.6x6.6x5.4mm
2402-001042	C891	C-AL, SMD	100uF, 20%, 16V, GP, TP, 6.6x6.6x5.4mm
2402-001042	C892	C-AL, SMD	100uF, 20%, 16V, GP, TP, 6.6x6.6x5.4mm
2402-001042	C895	C-AL, SMD	100uF, 20%, 16V, GP, TP, 6.6x6.6x5.4mm
2402-001042	U127	C-AL, SMD	100uF, 20%, 16V, GP, TP, 6.6x6.6x5.4mm
2402-001086	C9567	C-AL, SMD	100UF, 20%, 16V, WT, TP, 6.6X6.6X5.3
2402-001086	U128	C-AL, SMD	100UF, 20%, 16V, WT, TP, 6.6X6.6X5.3
2402-001128	C845	C-AL, SMD	100UF, 20%, 16V, WT, TP, 6.3X5.7MM
2402-001128	C851	C-AL, SMD	100UF, 20%, 16V, WT, TP, 6.3X5.7MM
2402-001128	C857	C-AL, SMD	100UF, 20%, 16V, WT, TP, 6.3X5.7MM
2402-001128	C898	C-AL, SMD	100UF, 20%, 16V, WT, TP, 6.3X5.7MM
2402-001155	C200	C-AL, SMD	47UF, 20%, 16V, WT, TP, 6.3X5.2MM
2402-001155	C288	C-AL, SMD	47UF, 20%, 16V, WT, TP, 6.3X5.2MM
2402-001155	C289	C-AL, SMD	47UF, 20%, 16V, WT, TP, 6.3X5.2MM
2402-001155	C329	C-AL, SMD	47UF, 20%, 16V, WT, TP, 6.3X5.2MM
2409-001046	C816	C-ORGANIC	39UF, 20%, 16V, WT, TP, 6.3X6 MM, -
2409-001049	C810	C-ORGANIC	47UF, 20%, 6.3V, FX, TP, 5X5.9MM, -
2409-001049	C813	C-ORGANIC	47UF, 20%, 6.3V, FX, TP, 5X5.9MM, -
2409-001049	C815	C-ORGANIC	47UF, 20%, 6.3V, FX, TP, 5X5.9MM, -
2409-001049	C818	C-ORGANIC	47UF, 20%, 6.3V, FX, TP, 5X5.9MM, -
2409-001049	C827	C-ORGANIC	47UF, 20%, 6.3V, FX, TP, 5X5.9MM, -
2409-001049	C865	C-ORGANIC	47UF, 20%, 6.3V, FX, TP, 5X5.9MM, -
2409-001049	C867	C-ORGANIC	47UF, 20%, 6.3V, FX, TP, 5X5.9MM, -
2409-001049	C869	C-ORGANIC	47UF, 20%, 6.3V, FX, TP, 5X5.9MM, -
2409-001049	C876	C-ORGANIC	47UF, 20%, 6.3V, FX, TP, 5X5.9MM, -
2409-001049	C890	C-ORGANIC	47UF, 20%, 6.3V, FX, TP, 5X5.9MM, -
2409-001049	U129	C-ORGANIC	47UF, 20%, 6.3V, FX, TP, 5X5.9MM, -
2503-001018	CA300	C-NETWORK	15PFX4, 10%, 50V, -
2503-001018	CA301	C-NETWORK	15PFX4, 10%, 50V, -
2503-001018	CA302	C-NETWORK	15PFX4, 10%, 50V, -
2503-001018	CA303	C-NETWORK	15PFX4, 10%, 50V, -
2503-001018	CA304	C-NETWORK	15PFX4, 10%, 50V, -
2503-001018	CA305	C-NETWORK	15PFX4, 10%, 50V, -
2703-000398	L008	INDUCTOR-SMD	10uH, 10%, 3.2x2.5x2.2mm
2703-001778	L201	INDUCTOR-SMD	3.3UH, 20%, 3.2X2.5X2.2MM
2703-001778	L202	INDUCTOR-SMD	3.3UH, 20%, 3.2X2.5X2.2MM
2703-001778	L203	INDUCTOR-SMD	3.3UH, 20%, 3.2X2.5X2.2MM
2703-001778	L204	INDUCTOR-SMD	3.3UH, 20%, 3.2X2.5X2.2MM
2703-001778	L205	INDUCTOR-SMD	3.3UH, 20%, 3.2X2.5X2.2MM

2703-001778	L206	INDUCTOR-SMD	3.3UH,20%,3.2X2.5X2.2MM	
2703-001778	L207	INDUCTOR-SMD	3.3UH,20%,3.2X2.5X2.2MM	
2703-001778	L208	INDUCTOR-SMD	3.3UH,20%,3.2X2.5X2.2MM	
2703-001778	L301	INDUCTOR-SMD	3.3UH,20%,3.2X2.5X2.2MM	
2703-001778	L555	INDUCTOR-SMD	3.3UH,20%,3.2X2.5X2.2MM	
2703-002327	L540	INDUCTOR-SMD	3.9UH,55,3.2X2.5X2.2MM	
2703-002327	L541	INDUCTOR-SMD	3.9UH,55,3.2X2.5X2.2MM	
2704-000001	FT925	INDUCTOR-SMD-ARRAY	4000HM,50V,0.5A,-,0.30HM,-25T085C	
2704-000001	FT926	INDUCTOR-SMD-ARRAY	4000HM,50V,0.5A,-,0.30HM,-25T085C	
2704-000001	FT933	INDUCTOR-SMD-ARRAY	4000HM,50V,0.5A,-,0.30HM,-25T085C	
2704-000001	FT934	INDUCTOR-SMD-ARRAY	4000HM,50V,0.5A,-,0.30HM,-25T085C	
2704-000004	FT935	INDUCTOR-SMD-ARRAY	2000HM,50V,0.5A,-,0.20HM,-25CT0+85C	
2801-003667	X201	CRYSTAL-SMD	14.3182MHZ,50PPM,28-AAN,16,500HM,TP	
2801-003843	X511	CRYSTAL-SMD	18.432MHz,30ppm,28-AAN,20pF,50ohm,TP	
2801-004117	X601	CRYSTAL-SMD	6MHZ,30PPM,28-ABX,20PF,1500HM,TP	
2901-001114	F187	FILTER-EMI SMD	25VDC,2.0ADC,-,100nF,3.2x1.6x1	
2901-001114	FT214	FILTER-EMI SMD	25VDC,2.0ADC,-,100nF,3.2x1.6x1	
2901-001114	FT281	FILTER-EMI SMD	25VDC,2.0ADC,-,100nF,3.2x1.6x1	
2901-001114	FT401	FILTER-EMI SMD	25VDC,2.0ADC,-,100nF,3.2x1.6x1	
2901-001114	FT901	FILTER-EMI SMD	25VDC,2.0ADC,-,100nF,3.2x1.6x1	
2901-001114	FT902	FILTER-EMI SMD	25VDC,2.0ADC,-,100nF,3.2x1.6x1	
2901-001114	FT903	FILTER-EMI SMD	25VDC,2.0ADC,-,100nF,3.2x1.6x1	
2901-001114	FT904	FILTER-EMI SMD	25VDC,2.0ADC,-,100nF,3.2x1.6x1	
2901-001114	FT923	FILTER-EMI SMD	25VDC,2.0ADC,-,100nF,3.2x1.6x1	
2901-001114	FT924	FILTER-EMI SMD	25VDC,2.0ADC,-,100nF,3.2x1.6x1	
3301-001145	FT201	CORE-FERRITE BEAD	AB,4.5x1.6x1.6mm,-,-	SNA
3301-001145	FT206	CORE-FERRITE BEAD	AB,4.5x1.6x1.6mm,-,-	SNA
3301-001145	FT210	CORE-FERRITE BEAD	AB,4.5x1.6x1.6mm,-,-	SNA
3301-001145	FT211	CORE-FERRITE BEAD	AB,4.5x1.6x1.6mm,-,-	SNA
3301-001145	FT304	CORE-FERRITE BEAD	AB,4.5x1.6x1.6mm,-,-	SNA
3301-001145	FT812	CORE-FERRITE BEAD	AB,4.5x1.6x1.6mm,-,-	SNA
3301-001145	FT813	CORE-FERRITE BEAD	AB,4.5x1.6x1.6mm,-,-	SNA
3301-001145	FT814	CORE-FERRITE BEAD	AB,4.5x1.6x1.6mm,-,-	SNA
3301-001145	FT815	CORE-FERRITE BEAD	AB,4.5x1.6x1.6mm,-,-	SNA
3301-001145	FT816	CORE-FERRITE BEAD	AB,4.5x1.6x1.6mm,-,-	SNA
3301-001145	FT817	CORE-FERRITE BEAD	AB,4.5x1.6x1.6mm,-,-	SNA
3301-001145	FT818	CORE-FERRITE BEAD	AB,4.5x1.6x1.6mm,-,-	SNA
3301-001145	FT821	CORE-FERRITE BEAD	AB,4.5x1.6x1.6mm,-,-	SNA
3301-001145	FT822	CORE-FERRITE BEAD	AB,4.5x1.6x1.6mm,-,-	SNA
3301-001145	FT824	CORE-FERRITE BEAD	AB,4.5x1.6x1.6mm,-,-	SNA
3301-001145	FT825	CORE-FERRITE BEAD	AB,4.5x1.6x1.6mm,-,-	SNA
3301-001145	FT851	CORE-FERRITE BEAD	AB,4.5x1.6x1.6mm,-,-	SNA
3301-001145	FT852	CORE-FERRITE BEAD	AB,4.5x1.6x1.6mm,-,-	SNA
3301-001145	FT877	CORE-FERRITE BEAD	AB,4.5x1.6x1.6mm,-,-	SNA
3301-001145	FT878	CORE-FERRITE BEAD	AB,4.5x1.6x1.6mm,-,-	SNA
3301-001145	FT927	CORE-FERRITE BEAD	AB,4.5x1.6x1.6mm,-,-	SNA
3301-001145	U130	CORE-FERRITE BEAD	AB,4.5x1.6x1.6mm,-,-	SNA
3301-001605	FT928	CORE-FERRITE BEAD	AB,3600HM,2.0X1.2X1.2MM,100MA,TP,FERRITE,0.50HM	SNA
3301-001605	FT929	CORE-FERRITE BEAD	AB,3600HM,2.0X1.2X1.2MM,100MA,TP,FERRITE,0.50HM	SNA
3301-001605	FT930	CORE-FERRITE BEAD	AB,3600HM,2.0X1.2X1.2MM,100MA,TP,FERRITE,0.50HM	SNA
3301-001605	FT931	CORE-FERRITE BEAD	AB,3600HM,2.0X1.2X1.2MM,100MA,TP,FERRITE,0.50HM	SNA
3301-001605	FT932	CORE-FERRITE BEAD	AB,3600HM,2.0X1.2X1.2MM,100MA,TP,FERRITE,0.50HM	SNA
3704-000249	IC620_SOCKET	SOCKET-IC	32P,PLCC,SN,1.27mm	
3711-000556	CN701	CONNECTOR-HEADER	BOX,12P,1R,1.25mm,SMD-A,SN	SNA
3711-000922	CN501	CONNECTOR-HEADER	BOX,4P,1R,1.25mm,SMD-A,SN	
3711-002046	CN512	CONNECTOR-HEADER	3WALL,12P,1R,1.25mm,SMD-S,SN	SNA
3711-002049	CN511	CONNECTOR-HEADER	BOX,6P,1R,1.25mm,SMD-A,SN	SNA
3711-002127	CN754	CONNECTOR-HEADER	BOX,8P,1R,1.25mm,SMD-A,SN	SNA
3711-003161	CN901	CONNECTOR-HEADER	BOX,20P,1R,1.25mm,ANGLE,SN	

3711-004130	CN575	CONNECTOR-HEADER	BOX, 31P, 2R, 0.625mm, SMD-A, AUF	
3711-004933	CN502	CONNECTOR-HEADER	BOX, 3P, 1R, 1.25MM, SMD-A, SN, WHT	SNA
3711-004933	CN706_1	CONNECTOR-HEADER	BOX, 3P, 1R, 1.25MM, SMD-A, SN, WHT	SNA
3711-005154	CN505	CONNECTOR-HEADER	BOX, 21P, 2R, 1.25MM, SMD-A, AUF, BLK	SNA
BN27-00009A	L806	COIL CHOKE	SMD 12X12X6, EOS, 33UH, 15%, -, 0.12 MAX, 2A, DR10X5.0MM, 18.5TS, 12X12X6, 1.8MM, 1UEW 0.	
BN27-00010A	L801	COIL CHOKE	-, NK17NS, 100UH, 10%, -, 0.7 MAX, 6A, DR5.8X4.5MM, 59.5TS, 6.0X5.2X4.5MM, 1.8MM, 1UEW 0.	
BN27-00010A	L804	COIL CHOKE	-, NK17NS, 100UH, 10%, -, 0.7 MAX, 6A, DR5.8X4.5MM, 59.5TS, 6.0X5.2X4.5MM, 1.8MM, 1UEW 0.	
BN27-20001A	L807	COIL-CHOKE	-, 53.0UH, 20%, DR10*5, -, -, -, 0.18ohm, -, -, -, TRAY	
BN27-20001A	L818	COIL-CHOKE	-, 53.0UH, 20%, DR10*5, -, -, -, 0.18ohm, -, -, -, TRAY	
BN41-00169A	MP1.0	PCB MAIN	MB15NOA, FR4, 6L, 175X181X1.23, MB15NOA	SNA
BN91-00445A	-	ASSY SHIELD	MB15UO	SNA
6003-000117	SH/PCB+C/F	SCREW-TAPTITE	BH, +, B, M3, L6, ZPC (YEL), SWRCH18A	SNA
6003-000117	SH/PCB+IN/PCB	SCREW-TAPTITE	BH, +, B, M3, L6, ZPC (YEL), SWRCH18A	SNA
6003-000117	SH/PCB+M/PCB	SCREW-TAPTITE	BH, +, B, M3, L6, ZPC (YEL), SWRCH18A	SNA
BN02-00010A	CIS	TAPE ETC	MINERVA, AL-TAPE, 0.07MM, 60MM, 80MM, SILVER, DK-100-60-80	SNA
BN59-00289A	CIS	BOARD-INPUT ASS'Y	MB15UO, INPUT ASS'Y	SNA
BN63-00440A	CIS	FELT-SPACER	MB15KO, FELT, TO.35, 10, 71.5, BLK	SNA
BN63-00440B	CIS	FELT-SPACER	MB15KO, FELT, TO.35, 10, 187, BLK	SNA
BN63-00495A	CIS	GASKET	MINERVA, CONDUCTIVE FABRIC, 0.13MM, 80MM, 80MM, GRAY, DK-K102-80-80, CONDUCTIVE TAPE	SNA
BN90-00256A	CIS	ASSY SHIELD-PCB	RB15, -, SECC TO.5, -, -, -, -	SNA
BN63-00177A	CIS	SHIELD-PCB	RB15, SECC, TO.5, -, -, -, -	SNA
BN71-00022A	CIS	EARTH PLATE	RB15AS, SUS, TO.15	SNA
BN92-00436A	-	ASSY BOX	MB15NO	SNA
BH68-00329A	CIS	LABEL BAR CODE	ALL, MPR11, DOM, EXPORT, ART-PAPER 90G, -, -, -, -, WHT, -, -	SNA
BH75-10529A	CIS	UNIT-HANDLE PACKING	LXA410TLMU, PE, -, WHITE, -	SNA
BN72-60001A	CIS	LEVER TOP	LSD210TL, PE-LD, WHITE, TFT_LCD	SNA
BN72-60002A	CIS	LEVER BOTTOM	LSD210TL, PE-LD, WHITE, TFT-LCD	SNA
BN69-00341B	CIS	BOX	LYM1525, ADC, CB-SW4, YEL, A-1, L523*W415*H90	SNA
BN92-00437A	-	ASSY LABEL	MB15NO	SNA
BN68-00267A	CIS	LABEL RATING	MB15UO, ADC, PE, TO.05, 65, 79, PE NATURE	SNA
BN92-00439A	-	ASSY P/MATERIAL	MB15NO	SNA
0203-001100	CIS	TAPE-OPP MASKING	OPP/W75/CLR, TO.05, W75, L800000, CLR	SNA
BH69-00256C	CIS	PAD-PACKING-EDGE	MV940, B400, W200, L2030, -, -, YEL, -, -	SNA
BH69-00260A	CIS	BAG AIR	DP17L, PE, 0.2, 1800, 1000, NATURAL, -	SNA
BH69-30002C	CIS	BAG-PE	LDPE, TO.05, W2400, NO_PRINT	SNA
BH69-30348C	CIS	BAG-PE	HDPE, TO.02, W350*L430, Y, -, CGB51	SNA
BH69-30355E	CIS	BAG-PE/N	NK15, PE FOAM, 0.5, 650, 650, NTR	SNA
BH69-30360A	CIS	BAG-AIR	HDPE, TO.2, W1000*L1800, N, -, ALL	SNA
BH69-40380A	CIS	PACKING-PAD	DW-2, 500X2200X200, -, CGK5527	SNA
BN69-00274A	CIS	CUSHION	RB15, EPS, -, -, -, -, -, M50	SNA
BN69-00293F	CIS	PALLET-PACKING	MB15, STEEL, 1290, 1080, 100	SNA
BN92-00578Z	-	ASSY ACCESSORY	LTM1525X/XAA, SEA, UNITED STATES	SNA
BN59-00224B	CIS	REMOCON	, TM71, NIKE, 42, GR20, NTSC, EX	
BN96-00145Z	CIS	ASSY ACCESSORY	LTM1525X/XAA, SEA, UNITED STATES	
0203-000214	CIS	TAPE-OPP MASKING	OPP/W50/CLR, TO.05, W50, L400000,	SNA
4301-000121	CIS	BATTERY-MN	1.5V, -, AAA, 10.5x44.5mm, HOLDER	SNA
BH39-10339X	CIS	CBF POWER CORD	DET, SVT, 125V/7A, BLK, 1830, WALL (ST), MSP-33, MSC-30	
BH39-40355W	CIS	CBF-HARNESS	-, 2000MM, IVORY, -, -, -	
BH69-30348D	CIS	BAG-PE	LDPE, TO.05, W240*L356, Y, -, CMG73	SNA
BN39-00043A	CIS	CBF SIGNAL	DETACHABLE, -, 15P/15P, -, -, -	
BN96-00159A	CIS	ASSY ACCESSORY	LTM1525X/XAA, SEA, UNITED STATES	
0203-000214	CIS	TAPE-OPP MASKING	OPP/W50/CLR, TO.05, W50, L400000,	SNA
AA68-00371C	CIS	CARD WARRANTY-01	, SEA, W/P100(G), 1 YEAR	SNA
BH68-00261P	CIS	MANUAL-00	SEAREGISTRATION CARD, SEA, E, USA, MOJO120G, 173, 234	SNA
BH69-30348D	CIS	BAG-PE	LDPE, TO.05, W240*L356, Y, -, CMG73	SNA
BN68-00281A	CIS	MANUAL USERS	LTM1525, SAMSUNG, E/F/S/P, ADC, MOJO100G	
EW-LTM1525X/XAA	-	3	LTM150XH-L06	Page 15
BN90-00297A	-	ASSY COVER REAR	MB15UO	SNA
6003-001246	C/F+C/R	SCREW-TAPTITE	FH, +, B, M3, L10, NI PLT, SWRCH18A	SNA

BN96-00038B	C1S	ASSY COVER P-REAR	MB15UO,USA,ABS HB,SVM-1207	
BN61-00092A	C1S	BRACKET-PIN	RB15,CU+ZN,TO.23,35MM	SNA
BN63-00173A	C1S	COVER-REAR	RB15,ABS,-,-,-,HB,-,BK08,SILVER SPRAY	SNA
BN63-00199A	C1S	COVER-HANDLE	RB15,ABS,HB,BK08,HB,1.5	SNA
BN90-00318A	-	ASSY STAND	MB15NO	SNA
BN90-00257A	C1S	ASSY STAND	RB15,-,ABD HB,-,-,-,-	
6001-001612	C1S	SCREW-MACHINE	CH,+,M2,L3.5,ZPC(BLK),SWRCH18A,FP,-	
6003-001347	C1S	SCREW-TAPTITE	FH,+,B,M4,L16,ZPC(YEL),SWRCH18A,-	SNA
BN61-00158A	C1S	BRACKET-STAND	MINERVA,STS 420J2,T2.0	SNA
BN63-00176A	C1S	COVER-STAND	RB15,ABS,-,-,-,HB,-,BK08,HB,1.5	SNA
BN73-60002A	C1S	RUBBER-FOOT	CY15PO,SPONGE,-,-,-,BL,-,-,-,-	SNA
BN90-00258A	C1S	ASSY HINGE	RB15,-,AL,-,-,-,-,DIE-CASTING	SNA
BN90-00341A	-	ASSY COVER FRONT	MB15UO	SNA
BN90-00255C	C1S	ASSY COVER FRONT	MB15UO,USA,ABS VO,SVM-1207	
6003-000259	C1S	SCREW-TAPTITE	BH,+,B,M3,L8,ZPC(YEL),SWRCH18A	SNA
BN59-00282A	C1S	SPEAKER SYSTEM	MINERVA,MINERVA-R,3W,46X46X20,3W 40HM, WIRE:395MM	
BN59-00283A	C1S	SPEAKER SYSTEM	MINERVA,MINERVA-L,3W,46X46X20,3W 40HM, WIRE:110MM	
BN59-00287A	C1S	BOARD-FUNCTION ASS'Y	MB15UO,CT5000-0610,FUNCTION ASS'Y	SNA
BN59-00288A	C1S	BOARD-PHONE JACK ASS'Y	MB15UO,CT5000-0620,PHONE-JACK ASS'Y	SNA
BN61-00082A	C1S	BRACKET-SPRING-STAND	RB15,SUS,TO.5,-,-,-,-	SNA
BN63-00172A	C1S	COVER-FRONT	RB15,ABS,-,-,-,HB,-,BK08,SILVER SPRAY	SNA
BN63-00175A	C1S	COVER-LENS	RB15,ABS,-,-,-,HB,-,IV16,NONE,1.5	SNA
BN64-00031A	C1S	BADGE-BRAND	RB15AS,AL,T1.4,6.3,40.1,-,SILIVER,-	SNA
BN64-00056A	C1S	KNOB-POWER	RB15,PC,-,-,-,HB,CLEAR,-,NI-CR	
BN64-00057A	C1S	KNOB-FUNCTION	RB15,ABS+PC,-,-,-,HB,BK08,-,NONE,1.5	
BN67-00048A	C1S	LENS-IR	RB15,ACRYL,CLEAR,-,1.5,-,HALF-MIRROR	SNA
BN67-00054A	C1S	LENS-LED	RB15,ACRYL,CLEAR,1	
BN91-00310F	C1S	ASSY MISC	MB15	SNA
BN44-00063A	C1S	ADAPTOR	AD-4914N,EOS17,100-240VAC,47 - 63 HZ,+14VDC,3.5A,-,49W,-,0 TO +40 C,120*63*31,SA	
BN91-00394A	-	ASSY CHASSIS	MB15NO	
BN94-00309A	-	ASSY PCB MAIN	MB15NO	SNA
0201-001223	C1S	ADHESIVE-TS	HT-130S,RED,700+/- 50,-	SNA
0202-001044	C1S	SOLDER-WIRE.	S63S-W3.0,S63S,D3,63Sn/37Pb,-	SNA
0202-001046	C1S	SOLDER-WIRE FLUX	CF-110VH-2A,-,-,-,-	SNA
0202-001222	C1S	SOLDER-WIRE FLUX	RS-107,RS60-1.2AA,D1.2,SN60/PB40,-	SNA
0204-001095	C1S	THINNER	#4520,-,-,-	SNA
BH73-60304E	C1S	RUBBER-SUPPORT	M015PS,CR VO,6*6*6.4,BLACK	SNA
BN39-00161B	C1S	LEAD CONNECTOR-ASSY	MB15UO,UL1571#30,UL/CSA,12P,#28,12505HS-12,12505HS-12,BK,40MM,1571#30,SJ02-01-05	
BN39-00272A	C1S	LEAD CONNECTOR-ASSY	MB15UO,UL1571#28,UL/CSA,20P,#28,12507HS-20,12507HS-20,BK,50MM,1571#28,SJ01-01-40	
BN39-00275A	C1S	LEAD CONNECTOR-ASSY	MB15UO,UL1061#28,UL/CSA,8P,#28,12505HS-08,12505HS-08,BK,125MM,1061#28,SJ02-01-06	
BN39-00287A	C1S	LEAD CONNECTOR-ASSY	MB15UO,UL1571#28,UL/CSA,21P,#28,FI-W21S,FI-W21S,BK,40MM,1571#28,SJ01-01-405(1)	
BN39-00288A	C1S	LEAD CONNECTOR-ASSY	MB15UO,UL1571#28,UL/CSA,31(25)P,#28,FI-W31S,FI-W31S,BK,40MM,1571#28,SJ01-01-405(
BN44-00061B	C1S	INVERTER	MB15UO,S1C540A,48KHZ,14VDC,3.6MARMS,6.8MARMS,48KHZ,140*65.5*7.0,4LAMP,48KHZ	
BN60-00011A	C1S	FASTENER-PEM/NUT	MINERVA,SUM24L(SN),M3,-,7.0,6.8,WHT	SNA
BN63-00174A	C1S	COVER-PCB	RB15,ABS,-,-,-,VO,-,IV16,TBBA,1.5	SNA
BN63-00345A	C1S	SHIELD-SUB	M015,SUS,TO.15	SNA
BN63-00413A	C1S	GASKET	MB15KO,CONDUCTIVE FABRIC,5MM,8MM,8MM,GRAY,71TSMK 8-5-8-13-D,71TSMK 8-5-8-13-D	SNA
BN97-00096M	-	ASSY MICOM	MB15NO	
1102-001129	IC620	IC-EPROM	M27W401,512KX8BIT,PLCC,32P,11.35X13.89MM,80NS,3.3V,10%,PLASTIC,-40TO+85C,-,CMOS,	
BN46-00012J	C1S	S/W MICOM	MB15NO	SNA
BN97-00100A	-	ASSY SMD	MB15NO	SNA
0202-001162	C1S	SOLDER-CREAM	RMA-20-21L,S63,-,SN63/PB36.6/AGO.4,FLUX9.5%	SNA
0401-001056	D409	DIODE-SWITCHING	MMBD4148SE,75V,200MA,SOT-23,TP	
0401-001056	D410	DIODE-SWITCHING	MMBD4148SE,75V,200MA,SOT-23,TP	
0401-001056	D411	DIODE-SWITCHING	MMBD4148SE,75V,200MA,SOT-23,TP	
0401-001056	D681	DIODE-SWITCHING	MMBD4148SE,75V,200MA,SOT-23,TP	
0401-001056	D804	DIODE-SWITCHING	MMBD4148SE,75V,200MA,SOT-23,TP	
0402-000553	D802	DIODE-RECTIFIER	SS24,40V,2.0A,DO-214AA	
0402-000553	D875	DIODE-RECTIFIER	SS24,40V,2.0A,DO-214AA	

0402-001098	D803	DIODE-RECTIFIER	SK34, 40V, 3A, SMC, TP
0403-000579	D601	DIODE-ZENER	BZX84C5V1, 5.1V, 5%, 200mW, SOT-23
0403-000579	D602	DIODE-ZENER	BZX84C5V1, 5.1V, 5%, 200mW, SOT-23
0403-000579	D604	DIODE-ZENER	BZX84C5V1, 5.1V, 5%, 200mW, SOT-23
0403-001052	D543	DIODE-ZENER	RD8.2MB, 8.2V, 7.7-8.64V, 200mW, S
0403-001052	D545	DIODE-ZENER	RD8.2MB, 8.2V, 7.7-8.64V, 200mW, S
0403-001052	D876	DIODE-ZENER	RD8.2MB, 8.2V, 7.7-8.64V, 200mW, S
0403-001052	D877	DIODE-ZENER	RD8.2MB, 8.2V, 7.7-8.64V, 200mW, S
0404-001166	D805	DIODE-SCHOTTKY	MBRM130LT3, 30V, 1000MA, DO-216AA, TP
0404-001166	D806	DIODE-SCHOTTKY	MBRM130LT3, 30V, 1000MA, DO-216AA, TP
0501-000342	Q01	TR-SMALL SIGNAL	KSC1623-Y, NPN, 200mW, SOT-23, TP, 135-270
0501-000342	Q611	TR-SMALL SIGNAL	KSC1623-Y, NPN, 200mW, SOT-23, TP, 135-270
0501-002080	Q601	TR-SMALL SIGNAL	2SC2412K, NPN, 200mW, SC-59, TP, 120-270
0501-002080	Q610	TR-SMALL SIGNAL	2SC2412K, NPN, 200mW, SC-59, TP, 120-270
0501-002080	Q808	TR-SMALL SIGNAL	2SC2412K, NPN, 200mW, SC-59, TP, 120-270
0501-002080	Q809	TR-SMALL SIGNAL	2SC2412K, NPN, 200mW, SC-59, TP, 120-270
0501-002080	Q810	TR-SMALL SIGNAL	2SC2412K, NPN, 200mW, SC-59, TP, 120-270
0501-002080	Q811	TR-SMALL SIGNAL	2SC2412K, NPN, 200mW, SC-59, TP, 120-270
0501-002080	Q812	TR-SMALL SIGNAL	2SC2412K, NPN, 200mW, SC-59, TP, 120-270
0505-001170	IC808	FET-SILICON	SI9933ADY-T1, P, -20V, 3.4A, 0.06ohm, 2W, SO-8
0801-002267	IC406	IC-CMOS LOGIC	74LCX14, -, SOIC, 14P, 150MIL, -, TP, -, -, -, 3.6V, -40TO+85C, -, 5.5V, -, -, 24MA
0801-002547	IC408	IC-CMOS LOGIC	74VHC157, MULTIPLEXER, SOP, 16P, 150MIL, QUAD, TP, PLASTIC, -, -, 0.36V, -40to+85C, -, 1.5V, 4
0904-001009	IC631	IC-I/O SUPPORT CHIP	8574A, -, SOP, 16P, 300MIL, 100KHz,
0904-001009	IC632	IC-I/O SUPPORT CHIP	8574A, -, SOP, 16P, 300MIL, 100KHz,
1001-001082	IC403	IC-VIDEO SWITCH	BA7657F, -, SOP, 24P, 300MIL, SINGL
1001-001109	IC681	IC-ANALOG SWITCH	FST3125M, BUS SWITCH & CMOS, SOIC, 17P, 150MIL, QUAD, 7V, -40TO+85C, PLASTIC, -, 4.00HM, 5.
1002-001292	IC350	IC-A/D CONVERTER	AD9883AKST-110, 8BITS, QFP, 80P, 551MIL, ±0.5LSB, TR, CMOS, PLASTIC, 3.3V, -25TO+85C, 650M
1003-001419	IC300	IC-DISPLAY DRIVER	MN82860, QFP, 208P, 1102MIL, -, -, TR, PLASTIC, 3.3V, -, 2.3W, -, -
1103-000129	IC401	IC-EEPROM	24C02, 256x8BIT, SOP, 8P, 150MIL, 1
1103-000138	IC603	IC-EEPROM	24C16, 2Kx8BIT, SOP, 8P, 150MIL, 10
1109-001209	IC210	IC-GRAM	M32L32321SA, 2X512KX32BIT, QFP, 100P, -, 7NS, 3.3V, 10%, PLASTIC, -55TO+150C, 2MA, CMOS, TR
1109-001209	IC211	IC-GRAM	M32L32321SA, 2X512KX32BIT, QFP, 100P, -, 7NS, 3.3V, 10%, PLASTIC, -55TO+150C, 2MA, CMOS, TR
1201-001559	IC503	IC-AUDIO AMP	4863, TSSOP, 20P, 173MIL, DUAL, 98dB, PLASTIC, 5.5V, 2.45W, -40to+85C, -, -, -, -
1203-000404	IC811	IC-DC/DC CONVERTER	34063, SOP, 8P, 150MIL, PLASTIC, 1.0/1.3V, -, 0TO+70C, 4.0MA, -, ST
1203-000404	IC812	IC-DC/DC CONVERTER	34063, SOP, 8P, 150MIL, PLASTIC, 1.0/1.3V, -, 0TO+70C, 4.0MA, -, ST
1203-001212	IC604	IC-VOL. DETECTOR	7029, SOT-89, 3P, -, PLASTIC, -, 500
1203-001293	IC301	IC-POSITIVE FIXED REG.	033, TO-252, 3P, 6.5MIL, PLASTIC, 3
1203-001293	IC813	IC-POSITIVE FIXED REG.	033, TO-252, 3P, 6.5MIL, PLASTIC, 3
1203-001448	IC804	IC-SWITCH VOL. REG.	2596, TO-263, 5P, -, PLASTIC, 4.750
1203-001448	IC807	IC-SWITCH VOL. REG.	2596, TO-263, 5P, -, PLASTIC, 4.750
1203-001816	IC803	IC-POSITIVE FIXED REG.	78M08, TO-252, 3P, -, PLASTIC, 7.7/8.3V, 1.0W, -40TO+85C, 0.5A, -, TP
1203-001830	IC805	IC-SWITCH VOL. REG.	2676, TO-263, 7P, -, PLASTIC, 3.234/3.336V, -, -40TO+125C, 3A, -, TP
1203-001890	IC802	IC-VOLTAGE REGULATOR	3961, SOT223-5, 5P, -, PLASTIC, 2.5V, -, -40to+125C, 800mA, -, TR
1203-001890	IC806	IC-VOLTAGE REGULATOR	3961, SOT223-5, 5P, -, PLASTIC, 2.5V, -, -40to+125C, 800mA, -, TR
1204-001551	IC175	IC-VIDEO SYSTEM	GS1881, SOIC, 8P, 150MIL, PLASTIC, 13.2V, -, 0TO+70C, TP, VIDEO SYNC SEPARATOR
1204-001852	IC919	IC-SOUND PROCESSOR	MSP3421G-B8, PQFP, 80P, -, PLASTIC, 9V, 1000MW, 0T070C, TR, -
1204-001911	IC200	IC-VIDEO PROCESS	DPTV-3D-6730, PQFP, 208P, 28X28MM, PLASTIC, 4.6V, -, 0TO+70C, TR, -
1204-001912	IC601	IC-DECODER	SDA5550M, P-MQFP, 100P, -, PLASTIC, 3.3V, 1.5W, 0TO+70C, TR, -
1205-001740	IC901	IC-TRANSMITTER	DS90C385, TSSOP, 56P, 240MIL, PLASTIC, 4V, 1.63W, -10 TO +70C, ST, FPD LINK-85MHZ (LVDS)
1206-000111	ICA5	IC-TIMER	KA555D/T.R, SOP, 8P, 150MIL, -, 18V
2007-000052	R4564	R-CHIP	10Kohm, 1%, 1/16W, DA, TP, 1608
2007-000052	R4565	R-CHIP	10Kohm, 1%, 1/16W, DA, TP, 1608
2007-000052	R4566	R-CHIP	10Kohm, 1%, 1/16W, DA, TP, 1608
2007-000052	R4567	R-CHIP	10Kohm, 1%, 1/16W, DA, TP, 1608
2007-000052	RA0	R-CHIP	10Kohm, 1%, 1/16W, DA, TP, 1608
2007-000070	R303	R-CHIP	0ohm, 5%, 1/16W, DA, TP, 1608
2007-000070	R328	R-CHIP	0ohm, 5%, 1/16W, DA, TP, 1608
2007-000070	R638	R-CHIP	0ohm, 5%, 1/16W, DA, TP, 1608
2007-000070	R902	R-CHIP	0ohm, 5%, 1/16W, DA, TP, 1608

2007-000074	R663	R-CHIP	100ohm,5%,1/16W,DA,TP,1608
2007-000074	R664	R-CHIP	100ohm,5%,1/16W,DA,TP,1608
2007-000074	R667	R-CHIP	100ohm,5%,1/16W,DA,TP,1608
2007-000074	R670	R-CHIP	100ohm,5%,1/16W,DA,TP,1608
2007-000074	R683	R-CHIP	100ohm,5%,1/16W,DA,TP,1608
2007-000074	R685	R-CHIP	100ohm,5%,1/16W,DA,TP,1608
2007-000074	R686	R-CHIP	100ohm,5%,1/16W,DA,TP,1608
2007-000074	R687	R-CHIP	100ohm,5%,1/16W,DA,TP,1608
2007-000074	RA1	R-CHIP	100ohm,5%,1/16W,DA,TP,1608
2007-000074	RA2	R-CHIP	100ohm,5%,1/16W,DA,TP,1608
2007-000075	R639	R-CHIP	220ohm,5%,1/16W,DA,TP,1608
2007-000075	R642	R-CHIP	220ohm,5%,1/16W,DA,TP,1608
2007-000075	R651	R-CHIP	220ohm,5%,1/16W,DA,TP,1608
2007-000075	R680	R-CHIP	220ohm,5%,1/16W,DA,TP,1608
2007-000075	R682	R-CHIP	220ohm,5%,1/16W,DA,TP,1608
2007-000075	RA3	R-CHIP	220ohm,5%,1/16W,DA,TP,1608
2007-000076	R665	R-CHIP	330ohm,5%,1/16W,DA,TP,1608
2007-000076	R666	R-CHIP	330ohm,5%,1/16W,DA,TP,1608
2007-000076	R668	R-CHIP	330ohm,5%,1/16W,DA,TP,1608
2007-000076	R671	R-CHIP	330ohm,5%,1/16W,DA,TP,1608
2007-000076	R672	R-CHIP	330ohm,5%,1/16W,DA,TP,1608
2007-000076	R673	R-CHIP	330ohm,5%,1/16W,DA,TP,1608
2007-000077	R4005	R-CHIP	470ohm,5%,1/16W,DA,TP,1608
2007-000077	R4009	R-CHIP	470ohm,5%,1/16W,DA,TP,1608
2007-000077	R623	R-CHIP	470ohm,5%,1/16W,DA,TP,1608
2007-000078	R505	R-CHIP	1Kohm,5%,1/16W,DA,TP,1608
2007-000078	R506	R-CHIP	1Kohm,5%,1/16W,DA,TP,1608
2007-000078	R509	R-CHIP	1Kohm,5%,1/16W,DA,TP,1608
2007-000078	R510	R-CHIP	1Kohm,5%,1/16W,DA,TP,1608
2007-000078	R516	R-CHIP	1Kohm,5%,1/16W,DA,TP,1608
2007-000078	R517	R-CHIP	1Kohm,5%,1/16W,DA,TP,1608
2007-000078	R520	R-CHIP	1Kohm,5%,1/16W,DA,TP,1608
2007-000078	R521	R-CHIP	1Kohm,5%,1/16W,DA,TP,1608
2007-000078	R522	R-CHIP	1Kohm,5%,1/16W,DA,TP,1608
2007-000078	R529	R-CHIP	1Kohm,5%,1/16W,DA,TP,1608
2007-000078	R531	R-CHIP	1Kohm,5%,1/16W,DA,TP,1608
2007-000078	R604	R-CHIP	1Kohm,5%,1/16W,DA,TP,1608
2007-000080	R807	R-CHIP	2Kohm,5%,1/16W,DA,TP,1608
2007-000082	R356	R-CHIP	3.3Kohm,5%,1/16W,DA,TP,1608
2007-000082	R4006	R-CHIP	3.3Kohm,5%,1/16W,DA,TP,1608
2007-000082	R4010	R-CHIP	3.3Kohm,5%,1/16W,DA,TP,1608
2007-000082	R4551	R-CHIP	3.3Kohm,5%,1/16W,DA,TP,1608
2007-000084	R02	R-CHIP	4.7Kohm,5%,1/16W,DA,TP,1608
2007-000084	R239	R-CHIP	4.7Kohm,5%,1/16W,DA,TP,1608
2007-000084	R302	R-CHIP	4.7Kohm,5%,1/16W,DA,TP,1608
2007-000084	R527	R-CHIP	4.7Kohm,5%,1/16W,DA,TP,1608
2007-000084	R617	R-CHIP	4.7Kohm,5%,1/16W,DA,TP,1608
2007-000084	R631	R-CHIP	4.7Kohm,5%,1/16W,DA,TP,1608
2007-000084	R636	R-CHIP	4.7Kohm,5%,1/16W,DA,TP,1608
2007-000084	R646	R-CHIP	4.7Kohm,5%,1/16W,DA,TP,1608
2007-000084	R648	R-CHIP	4.7Kohm,5%,1/16W,DA,TP,1608
2007-000084	R649	R-CHIP	4.7Kohm,5%,1/16W,DA,TP,1608
2007-000084	R674	R-CHIP	4.7Kohm,5%,1/16W,DA,TP,1608
2007-000084	R675	R-CHIP	4.7Kohm,5%,1/16W,DA,TP,1608
2007-000084	R821	R-CHIP	4.7Kohm,5%,1/16W,DA,TP,1608
2007-000084	R822	R-CHIP	4.7Kohm,5%,1/16W,DA,TP,1608
2007-000084	R841	R-CHIP	4.7Kohm,5%,1/16W,DA,TP,1608
2007-000084	R842	R-CHIP	4.7Kohm,5%,1/16W,DA,TP,1608
2007-000084	R891	R-CHIP	4.7Kohm,5%,1/16W,DA,TP,1608

2007-000090	R208	R-CHIP	10KOHM, 5%, 1/16W, DA, TP, 1608
2007-000090	R241	R-CHIP	10KOHM, 5%, 1/16W, DA, TP, 1608
2007-000090	R248	R-CHIP	10KOHM, 5%, 1/16W, DA, TP, 1608
2007-000090	R301	R-CHIP	10KOHM, 5%, 1/16W, DA, TP, 1608
2007-000090	R327	R-CHIP	10KOHM, 5%, 1/16W, DA, TP, 1608
2007-000090	R357	R-CHIP	10KOHM, 5%, 1/16W, DA, TP, 1608
2007-000090	R358	R-CHIP	10KOHM, 5%, 1/16W, DA, TP, 1608
2007-000090	R601	R-CHIP	10KOHM, 5%, 1/16W, DA, TP, 1608
2007-000090	R607	R-CHIP	10KOHM, 5%, 1/16W, DA, TP, 1608
2007-000090	R609	R-CHIP	10KOHM, 5%, 1/16W, DA, TP, 1608
2007-000090	R621	R-CHIP	10KOHM, 5%, 1/16W, DA, TP, 1608
2007-000090	R622	R-CHIP	10KOHM, 5%, 1/16W, DA, TP, 1608
2007-000090	R653	R-CHIP	10KOHM, 5%, 1/16W, DA, TP, 1608
2007-000090	R654	R-CHIP	10KOHM, 5%, 1/16W, DA, TP, 1608
2007-000090	R655	R-CHIP	10KOHM, 5%, 1/16W, DA, TP, 1608
2007-000090	R656	R-CHIP	10KOHM, 5%, 1/16W, DA, TP, 1608
2007-000090	R657	R-CHIP	10KOHM, 5%, 1/16W, DA, TP, 1608
2007-000090	R658	R-CHIP	10KOHM, 5%, 1/16W, DA, TP, 1608
2007-000090	R659	R-CHIP	10KOHM, 5%, 1/16W, DA, TP, 1608
2007-000090	R661	R-CHIP	10KOHM, 5%, 1/16W, DA, TP, 1608
2007-000090	R676	R-CHIP	10KOHM, 5%, 1/16W, DA, TP, 1608
2007-000090	R677	R-CHIP	10KOHM, 5%, 1/16W, DA, TP, 1608
2007-000090	R678	R-CHIP	10KOHM, 5%, 1/16W, DA, TP, 1608
2007-000090	R684	R-CHIP	10KOHM, 5%, 1/16W, DA, TP, 1608
2007-000090	R823	R-CHIP	10KOHM, 5%, 1/16W, DA, TP, 1608
2007-000090	R824	R-CHIP	10KOHM, 5%, 1/16W, DA, TP, 1608
2007-000090	R873	R-CHIP	10KOHM, 5%, 1/16W, DA, TP, 1608
2007-000091	R4560	R-CHIP	12Kohm, 5%, 1/16W, DA, TP, 1608
2007-000091	R4561	R-CHIP	12Kohm, 5%, 1/16W, DA, TP, 1608
2007-000091	R4562	R-CHIP	12Kohm, 5%, 1/16W, DA, TP, 1608
2007-000091	R4563	R-CHIP	12Kohm, 5%, 1/16W, DA, TP, 1608
2007-000092	R4568	R-CHIP	15Kohm, 5%, 1/16W, DA, TP, 1608
2007-000092	R4569	R-CHIP	15Kohm, 5%, 1/16W, DA, TP, 1608
2007-000093	R312	R-CHIP	20Kohm, 5%, 1/16W, DA, TP, 1608
2007-000097	R608	R-CHIP	47Kohm, 5%, 1/16W, DA, TP, 1608
2007-000098	R690	R-CHIP	56Kohm, 5%, 1/16W, DA, TP, 1608
2007-000102	R553	R-CHIP	100Kohm, 5%, 1/16W, DA, TP, 1608
2007-000102	R554	R-CHIP	100Kohm, 5%, 1/16W, DA, TP, 1608
2007-000102	R874	R-CHIP	100Kohm, 5%, 1/16W, DA, TP, 1608
2007-000107	R404	R-CHIP	470Kohm, 5%, 1/16W, DA, TP, 1608
2007-000109	R305	R-CHIP	1Mohm, 5%, 1/16W, DA, TP, 1608
2007-000109	R309	R-CHIP	1Mohm, 5%, 1/16W, DA, TP, 1608
2007-000109	R317	R-CHIP	1Mohm, 5%, 1/16W, DA, TP, 1608
2007-000113	R201	R-CHIP	33ohm, 5%, 1/16W, DA, TP, 1608
2007-000113	R202	R-CHIP	33ohm, 5%, 1/16W, DA, TP, 1608
2007-000113	R203	R-CHIP	33ohm, 5%, 1/16W, DA, TP, 1608
2007-000113	R204	R-CHIP	33ohm, 5%, 1/16W, DA, TP, 1608
2007-000113	R205	R-CHIP	33ohm, 5%, 1/16W, DA, TP, 1608
2007-000113	R206	R-CHIP	33ohm, 5%, 1/16W, DA, TP, 1608
2007-000113	R207	R-CHIP	33ohm, 5%, 1/16W, DA, TP, 1608
2007-000113	R219	R-CHIP	33ohm, 5%, 1/16W, DA, TP, 1608
2007-000116	R238	R-CHIP	120ohm, 5%, 1/16W, DA, TP, 1608
2007-000116	R4007	R-CHIP	120ohm, 5%, 1/16W, DA, TP, 1608
2007-000116	R906	R-CHIP	120ohm, 5%, 1/16W, DA, TP, 1608
2007-000118	R235	R-CHIP	390ohm, 5%, 1/16W, DA, TP, 1608
2007-000119	R4556	R-CHIP	560ohm, 5%, 1/16W, DA, TP, 1608
2007-000119	R4557	R-CHIP	560ohm, 5%, 1/16W, DA, TP, 1608
2007-000119	R4558	R-CHIP	560ohm, 5%, 1/16W, DA, TP, 1608
2007-000119	R4559	R-CHIP	560ohm, 5%, 1/16W, DA, TP, 1608

2007-000120	R645	R-CHIP	680ohm, 5%, 1/16W, DA, TP, 1608
2007-000123	R01	R-CHIP	1.5Kohm, 5%, 1/16W, DA, TP, 1608
2007-000124	R944	R-CHIP	2.2Kohm, 5%, 1/16W, DA, TP, 1608
2007-000134	R511	R-CHIP	33Kohm, 5%, 1/16W, DA, TP, 1608
2007-000134	R539	R-CHIP	33Kohm, 5%, 1/16W, DA, TP, 1608
2007-000219	R806	R-CHIP	1.2Kohm, 1%, 1/16W, DA, TP, 1608
2007-000219	R809	R-CHIP	1.2Kohm, 1%, 1/16W, DA, TP, 1608
2007-000239	R612	R-CHIP	1.5Kohm, 1%, 1/16W, DA, TP, 1608
2007-000239	R613	R-CHIP	1.5Kohm, 1%, 1/16W, DA, TP, 1608
2007-000309	R214	R-CHIP	10ohm, 5%, 1/16W, DA, TP, 1608
2007-000309	R215	R-CHIP	10ohm, 5%, 1/16W, DA, TP, 1608
2007-000309	R224	R-CHIP	10ohm, 5%, 1/16W, DA, TP, 1608
2007-000309	R692	R-CHIP	10ohm, 5%, 1/16W, DA, TP, 1608
2007-000309	R693	R-CHIP	10ohm, 5%, 1/16W, DA, TP, 1608
2007-000309	RJ15	R-CHIP	10ohm, 5%, 1/16W, DA, TP, 1608
2007-000309	RJ16	R-CHIP	10ohm, 5%, 1/16W, DA, TP, 1608
2007-000309	RJ17	R-CHIP	10ohm, 5%, 1/16W, DA, TP, 1608
2007-000402	R610	R-CHIP	150ohm, 5%, 1/16W, DA, TP, 1608
2007-000402	R611	R-CHIP	150ohm, 5%, 1/16W, DA, TP, 1608
2007-000402	R620	R-CHIP	150ohm, 5%, 1/16W, DA, TP, 1608
2007-000402	R943	R-CHIP	150ohm, 5%, 1/16W, DA, TP, 1608
2007-000616	R318	R-CHIP	24Kohm, 5%, 1/16W, DA, TP, 1608
2007-000701	R810	R-CHIP	3.6Kohm, 1%, 1/16W, DA, TP, 1608
2007-000882	R4571	R-CHIP	4.7ohm, 5%, 1/16W, DA, TP, 1608
2007-000882	R4572	R-CHIP	4.7ohm, 5%, 1/16W, DA, TP, 1608
2007-001039	R602	R-CHIP	56KOHM, 5%, 1/10W, DA, TP, 2012
2007-001114	R4008	R-CHIP	680Kohm, 5%, 1/16W, DA, TP, 1608
2007-001164	R307	R-CHIP	75ohm, 1%, 1/16W, DA, TP, 1608
2007-001164	R308	R-CHIP	75ohm, 1%, 1/16W, DA, TP, 1608
2007-001164	R310	R-CHIP	75ohm, 1%, 1/16W, DA, TP, 1608
2007-001164	R311	R-CHIP	75ohm, 1%, 1/16W, DA, TP, 1608
2007-001164	R313	R-CHIP	75ohm, 1%, 1/16W, DA, TP, 1608
2007-001164	R319	R-CHIP	75ohm, 1%, 1/16W, DA, TP, 1608
2007-001167	R236	R-CHIP	75ohm, 5%, 1/16W, DA, TP, 1608
2007-001167	R401	R-CHIP	75ohm, 5%, 1/16W, DA, TP, 1608
2007-001167	R402	R-CHIP	75ohm, 5%, 1/16W, DA, TP, 1608
2007-001167	R403	R-CHIP	75ohm, 5%, 1/16W, DA, TP, 1608
2007-001167	R619	R-CHIP	75ohm, 5%, 1/16W, DA, TP, 1608
2007-008433	R4570	R-CHIP	0.330HM, 1%, 1W, DA, TP, 6432
2007-008433	R805	R-CHIP	0.330HM, 1%, 1W, DA, TP, 6432
2007-008433	R808	R-CHIP	0.330HM, 1%, 1W, DA, TP, 6432
2011-000002	RA301	R-NETWORK	22ohm, 5%, 63mW, L, CHIP, 8P, TP
2011-000002	RA302	R-NETWORK	22ohm, 5%, 63mW, L, CHIP, 8P, TP
2011-000002	RA303	R-NETWORK	22ohm, 5%, 63mW, L, CHIP, 8P, TP
2011-000002	RA304	R-NETWORK	22ohm, 5%, 63mW, L, CHIP, 8P, TP
2011-000002	RA305	R-NETWORK	22ohm, 5%, 63mW, L, CHIP, 8P, TP
2011-000002	RA306	R-NETWORK	22ohm, 5%, 63mW, L, CHIP, 8P, TP
2011-000515	RA610	R-NETWORK	4.7Kohm, 5%, 1/16W, L, CHIP, 8P, TP
2011-000515	RA611	R-NETWORK	4.7Kohm, 5%, 1/16W, L, CHIP, 8P, TP
2011-000651	RA601	R-NETWORK	10ohm, 5%, 63mW, L, CHIP, 8P, TP
2011-000651	RA602	R-NETWORK	10ohm, 5%, 63mW, L, CHIP, 8P, TP
2011-000651	RA603	R-NETWORK	10ohm, 5%, 63mW, L, CHIP, 8P, TP
2011-000651	RA604	R-NETWORK	10ohm, 5%, 63mW, L, CHIP, 8P, TP
2011-000651	RA605	R-NETWORK	10ohm, 5%, 63mW, L, CHIP, 8P, TP
2011-000651	RA606	R-NETWORK	10ohm, 5%, 63mW, L, CHIP, 8P, TP
2011-000651	RA607	R-NETWORK	10ohm, 5%, 63mW, L, CHIP, 8P, TP
2011-000651	RA608	R-NETWORK	10ohm, 5%, 63mW, L, CHIP, 8P, TP
2011-000651	RA609	R-NETWORK	10ohm, 5%, 63mW, L, CHIP, 8P, TP
2203-000140	C538	C-CERAMIC, CHIP	1.5nF, 10%, 50V, X7R, TP, 1608, -

2203-000257	C9566	C-CERAMIC,CHIP	10nF,10%,50V,X7R,TP,1608
2203-000257	C9568	C-CERAMIC,CHIP	10nF,10%,50V,X7R,TP,1608
2203-000257	C9584	C-CERAMIC,CHIP	10nF,10%,50V,X7R,TP,1608
2203-000257	C9593	C-CERAMIC,CHIP	10nF,10%,50V,X7R,TP,1608
2203-000257	U122	C-CERAMIC,CHIP	10nF,10%,50V,X7R,TP,1608
2203-000260	C618	C-CERAMIC,CHIP	10nF,10%,50V,X7R,TP,2012
2203-000280	C527	C-CERAMIC,CHIP	0.01nF,0.5pF,50V,NP0,TP,1608
2203-000280	C572	C-CERAMIC,CHIP	0.01nF,0.5pF,50V,NP0,TP,1608
2203-000316	C814	C-CERAMIC,CHIP	0.12nF,5%,50V,NP0,TP,2012
2203-000316	C817	C-CERAMIC,CHIP	0.12nF,5%,50V,NP0,TP,2012
2203-000440	C301	C-CERAMIC,CHIP	1nF,10%,50V,X7R,TP,1608,-
2203-000440	C536	C-CERAMIC,CHIP	1nF,10%,50V,X7R,TP,1608,-
2203-000440	C537	C-CERAMIC,CHIP	1nF,10%,50V,X7R,TP,1608,-
2203-000440	C885	C-CERAMIC,CHIP	1nF,10%,50V,X7R,TP,1608,-
2203-000440	C901	C-CERAMIC,CHIP	1nF,10%,50V,X7R,TP,1608,-
2203-000440	C902	C-CERAMIC,CHIP	1nF,10%,50V,X7R,TP,1608,-
2203-000440	C905	C-CERAMIC,CHIP	1nF,10%,50V,X7R,TP,1608,-
2203-000440	C913	C-CERAMIC,CHIP	1nF,10%,50V,X7R,TP,1608,-
2203-000440	C914	C-CERAMIC,CHIP	1nF,10%,50V,X7R,TP,1608,-
2203-000440	C9569	C-CERAMIC,CHIP	1nF,10%,50V,X7R,TP,1608,-
2203-000440	C9570	C-CERAMIC,CHIP	1nF,10%,50V,X7R,TP,1608,-
2203-000440	C9571	C-CERAMIC,CHIP	1nF,10%,50V,X7R,TP,1608,-
2203-000552	C225	C-CERAMIC,CHIP	0.02nF,5%,50V,NP0,TP,1608
2203-000552	C226	C-CERAMIC,CHIP	0.02nF,5%,50V,NP0,TP,1608
2203-000552	C614	C-CERAMIC,CHIP	0.02nF,5%,50V,NP0,TP,1608
2203-000552	C615	C-CERAMIC,CHIP	0.02nF,5%,50V,NP0,TP,1608
2203-000626	C922	C-CERAMIC,CHIP	0.022nF,5%,50V,NP0,TP,1608
2203-000626	C923	C-CERAMIC,CHIP	0.022nF,5%,50V,NP0,TP,1608
2203-000626	C924	C-CERAMIC,CHIP	0.022nF,5%,50V,NP0,TP,1608
2203-000726	C381	C-CERAMIC,CHIP	3.9nF,10%,50V,X7R,TP,1608,-
2203-000815	C244	C-CERAMIC,CHIP	0.033nF,5%,50V,NP0,TP,1608
2203-000815	C290	C-CERAMIC,CHIP	0.033nF,5%,50V,NP0,TP,1608
2203-000815	C291	C-CERAMIC,CHIP	0.033nF,5%,50V,NP0,TP,1608
2203-000815	C292	C-CERAMIC,CHIP	0.033nF,5%,50V,NP0,TP,1608
2203-000815	C293	C-CERAMIC,CHIP	0.033nF,5%,50V,NP0,TP,1608
2203-000815	C294	C-CERAMIC,CHIP	0.033nF,5%,50V,NP0,TP,1608
2203-000815	C295	C-CERAMIC,CHIP	0.033nF,5%,50V,NP0,TP,1608
2203-000815	C296	C-CERAMIC,CHIP	0.033nF,5%,50V,NP0,TP,1608
2203-000815	C297	C-CERAMIC,CHIP	0.033nF,5%,50V,NP0,TP,1608
2203-000815	C298	C-CERAMIC,CHIP	0.033nF,5%,50V,NP0,TP,1608
2203-000815	C299	C-CERAMIC,CHIP	0.033nF,5%,50V,NP0,TP,1608
2203-000815	C304	C-CERAMIC,CHIP	0.033nF,5%,50V,NP0,TP,1608
2203-000815	C308	C-CERAMIC,CHIP	0.033nF,5%,50V,NP0,TP,1608
2203-000815	C309	C-CERAMIC,CHIP	0.033nF,5%,50V,NP0,TP,1608
2203-000815	C310	C-CERAMIC,CHIP	0.033nF,5%,50V,NP0,TP,1608
2203-000815	C312	C-CERAMIC,CHIP	0.033nF,5%,50V,NP0,TP,1608
2203-000815	C313	C-CERAMIC,CHIP	0.033nF,5%,50V,NP0,TP,1608
2203-000815	C314	C-CERAMIC,CHIP	0.033nF,5%,50V,NP0,TP,1608
2203-000815	C315	C-CERAMIC,CHIP	0.033nF,5%,50V,NP0,TP,1608
2203-000815	C316	C-CERAMIC,CHIP	0.033nF,5%,50V,NP0,TP,1608
2203-000815	C317	C-CERAMIC,CHIP	0.033nF,5%,50V,NP0,TP,1608
2203-000815	C320	C-CERAMIC,CHIP	0.033nF,5%,50V,NP0,TP,1608
2203-000815	C324	C-CERAMIC,CHIP	0.033nF,5%,50V,NP0,TP,1608
2203-000815	C325	C-CERAMIC,CHIP	0.033nF,5%,50V,NP0,TP,1608
2203-000815	C326	C-CERAMIC,CHIP	0.033nF,5%,50V,NP0,TP,1608
2203-000815	C330	C-CERAMIC,CHIP	0.033nF,5%,50V,NP0,TP,1608
2203-000815	C340	C-CERAMIC,CHIP	0.033nF,5%,50V,NP0,TP,1608
2203-000815	C366	C-CERAMIC,CHIP	0.033nF,5%,50V,NP0,TP,1608
2203-000815	C368	C-CERAMIC,CHIP	0.033nF,5%,50V,NP0,TP,1608

2203-000815	C371	C-CERAMIC,CHIP	0.033nF,5%,50V,NPO,TP,1608
2203-000815	C373	C-CERAMIC,CHIP	0.033nF,5%,50V,NPO,TP,1608
2203-000815	C375	C-CERAMIC,CHIP	0.033nF,5%,50V,NPO,TP,1608
2203-000815	C376	C-CERAMIC,CHIP	0.033nF,5%,50V,NPO,TP,1608
2203-000815	C454	C-CERAMIC,CHIP	0.033nF,5%,50V,NPO,TP,1608
2203-000815	C455	C-CERAMIC,CHIP	0.033nF,5%,50V,NPO,TP,1608
2203-000815	C456	C-CERAMIC,CHIP	0.033nF,5%,50V,NPO,TP,1608
2203-000815	C915	C-CERAMIC,CHIP	0.033nF,5%,50V,NPO,TP,1608
2203-000815	C9561	C-CERAMIC,CHIP	0.033nF,5%,50V,NPO,TP,1608
2203-000815	C9582	C-CERAMIC,CHIP	0.033nF,5%,50V,NPO,TP,1608
2203-000843	C379	C-CERAMIC,CHIP	39nF,10%,25V,X7R,TP,1608,-
2203-000972	C576	C-CERAMIC,CHIP	47nF,10%,16V,X7R,TP,1608
2203-000998	C306	C-CERAMIC,CHIP	0.047nF,5%,50V,NPO,TP,1608
2203-000998	C307	C-CERAMIC,CHIP	0.047nF,5%,50V,NPO,TP,1608
2203-000998	C3302	C-CERAMIC,CHIP	0.047nF,5%,50V,NPO,TP,1608
2203-001077	C567	C-CERAMIC,CHIP	0.056nF,5%,50V,NPO,TP,2012
2203-001077	C568	C-CERAMIC,CHIP	0.056nF,5%,50V,NPO,TP,2012
2203-001077	C571	C-CERAMIC,CHIP	0.056nF,5%,50V,NPO,TP,2012
2203-001077	C9572	C-CERAMIC,CHIP	0.056nF,5%,50V,NPO,TP,2012
2203-001077	C9573	C-CERAMIC,CHIP	0.056nF,5%,50V,NPO,TP,2012
2203-001077	C9574	C-CERAMIC,CHIP	0.056nF,5%,50V,NPO,TP,2012
2203-001077	C9575	C-CERAMIC,CHIP	0.056nF,5%,50V,NPO,TP,2012
2203-001607	C608	C-CERAMIC,CHIP	0.22nF,5%,50V,NPO,TP,1608
2203-001630	C9594	C-CERAMIC,CHIP	330nF,+80-20%,16V,Y5V,TP,1608
2203-001630	C9595	C-CERAMIC,CHIP	330nF,+80-20%,16V,Y5V,TP,1608
2203-001656	C404	C-CERAMIC,CHIP	0.47nF,5%,50V,NPO,TP,1608
2203-001656	C543	C-CERAMIC,CHIP	0.47nF,5%,50V,NPO,TP,1608
2203-001656	C569	C-CERAMIC,CHIP	0.47nF,5%,50V,NPO,TP,1608
2203-001656	C9564	C-CERAMIC,CHIP	0.47nF,5%,50V,NPO,TP,1608
2203-001656	C9565	C-CERAMIC,CHIP	0.47nF,5%,50V,NPO,TP,1608
2203-005005	C214	C-CERAMIC,CHIP	100nF,10%,16V,X7R,TP,1608
2203-005005	C215	C-CERAMIC,CHIP	100nF,10%,16V,X7R,TP,1608
2203-005005	C216	C-CERAMIC,CHIP	100nF,10%,16V,X7R,TP,1608
2203-005005	C217	C-CERAMIC,CHIP	100nF,10%,16V,X7R,TP,1608
2203-005005	C229	C-CERAMIC,CHIP	100nF,10%,16V,X7R,TP,1608
2203-005005	C238	C-CERAMIC,CHIP	100nF,10%,16V,X7R,TP,1608
2203-005005	C245	C-CERAMIC,CHIP	100nF,10%,16V,X7R,TP,1608
2203-005005	C249	C-CERAMIC,CHIP	100nF,10%,16V,X7R,TP,1608
2203-005005	C267	C-CERAMIC,CHIP	100nF,10%,16V,X7R,TP,1608
2203-005005	C274	C-CERAMIC,CHIP	100nF,10%,16V,X7R,TP,1608
2203-005005	C275	C-CERAMIC,CHIP	100nF,10%,16V,X7R,TP,1608
2203-005005	C276	C-CERAMIC,CHIP	100nF,10%,16V,X7R,TP,1608
2203-005005	C277	C-CERAMIC,CHIP	100nF,10%,16V,X7R,TP,1608
2203-005005	C278	C-CERAMIC,CHIP	100nF,10%,16V,X7R,TP,1608
2203-005005	C279	C-CERAMIC,CHIP	100nF,10%,16V,X7R,TP,1608
2203-005005	C282	C-CERAMIC,CHIP	100nF,10%,16V,X7R,TP,1608
2203-005005	C302	C-CERAMIC,CHIP	100nF,10%,16V,X7R,TP,1608
2203-005005	C303	C-CERAMIC,CHIP	100nF,10%,16V,X7R,TP,1608
2203-005005	C305	C-CERAMIC,CHIP	100nF,10%,16V,X7R,TP,1608
2203-005005	C318	C-CERAMIC,CHIP	100nF,10%,16V,X7R,TP,1608
2203-005005	C319	C-CERAMIC,CHIP	100nF,10%,16V,X7R,TP,1608
2203-005005	C321	C-CERAMIC,CHIP	100nF,10%,16V,X7R,TP,1608
2203-005005	C322	C-CERAMIC,CHIP	100nF,10%,16V,X7R,TP,1608
2203-005005	C323	C-CERAMIC,CHIP	100nF,10%,16V,X7R,TP,1608
2203-005005	C327	C-CERAMIC,CHIP	100nF,10%,16V,X7R,TP,1608
2203-005005	C328	C-CERAMIC,CHIP	100nF,10%,16V,X7R,TP,1608
2203-005005	C3303	C-CERAMIC,CHIP	100nF,10%,16V,X7R,TP,1608
2203-005005	C3304	C-CERAMIC,CHIP	100nF,10%,16V,X7R,TP,1608
2203-005005	C3305	C-CERAMIC,CHIP	100nF,10%,16V,X7R,TP,1608

2203-005005	C387	C-CERAMIC,CHIP	100nF,10%,16V,X7R,TP,1608
2203-005005	C388	C-CERAMIC,CHIP	100nF,10%,16V,X7R,TP,1608
2203-005005	C389	C-CERAMIC,CHIP	100nF,10%,16V,X7R,TP,1608
2203-005005	C391	C-CERAMIC,CHIP	100nF,10%,16V,X7R,TP,1608
2203-005005	C393	C-CERAMIC,CHIP	100nF,10%,16V,X7R,TP,1608
2203-005005	C397	C-CERAMIC,CHIP	100nF,10%,16V,X7R,TP,1608
2203-005005	C398	C-CERAMIC,CHIP	100nF,10%,16V,X7R,TP,1608
2203-005005	C399	C-CERAMIC,CHIP	100nF,10%,16V,X7R,TP,1608
2203-005005	C406	C-CERAMIC,CHIP	100nF,10%,16V,X7R,TP,1608
2203-005005	C485	C-CERAMIC,CHIP	100nF,10%,16V,X7R,TP,1608
2203-005005	C486	C-CERAMIC,CHIP	100nF,10%,16V,X7R,TP,1608
2203-005005	C492	C-CERAMIC,CHIP	100nF,10%,16V,X7R,TP,1608
2203-005005	C549	C-CERAMIC,CHIP	100nF,10%,16V,X7R,TP,1608
2203-005005	C551	C-CERAMIC,CHIP	100nF,10%,16V,X7R,TP,1608
2203-005005	C589	C-CERAMIC,CHIP	100nF,10%,16V,X7R,TP,1608
2203-005005	C601	C-CERAMIC,CHIP	100nF,10%,16V,X7R,TP,1608
2203-005005	C602	C-CERAMIC,CHIP	100nF,10%,16V,X7R,TP,1608
2203-005005	C605	C-CERAMIC,CHIP	100nF,10%,16V,X7R,TP,1608
2203-005005	C606	C-CERAMIC,CHIP	100nF,10%,16V,X7R,TP,1608
2203-005005	C607	C-CERAMIC,CHIP	100nF,10%,16V,X7R,TP,1608
2203-005005	C609	C-CERAMIC,CHIP	100nF,10%,16V,X7R,TP,1608
2203-005005	C613	C-CERAMIC,CHIP	100nF,10%,16V,X7R,TP,1608
2203-005005	C619	C-CERAMIC,CHIP	100nF,10%,16V,X7R,TP,1608
2203-005005	C625	C-CERAMIC,CHIP	100nF,10%,16V,X7R,TP,1608
2203-005005	C626	C-CERAMIC,CHIP	100nF,10%,16V,X7R,TP,1608
2203-005005	C824	C-CERAMIC,CHIP	100nF,10%,16V,X7R,TP,1608
2203-005005	C873	C-CERAMIC,CHIP	100nF,10%,16V,X7R,TP,1608
2203-005005	C874	C-CERAMIC,CHIP	100nF,10%,16V,X7R,TP,1608
2203-005005	C875	C-CERAMIC,CHIP	100nF,10%,16V,X7R,TP,1608
2203-005005	C884	C-CERAMIC,CHIP	100nF,10%,16V,X7R,TP,1608
2203-005005	C886	C-CERAMIC,CHIP	100nF,10%,16V,X7R,TP,1608
2203-005005	C912	C-CERAMIC,CHIP	100nF,10%,16V,X7R,TP,1608
2203-005005	C917	C-CERAMIC,CHIP	100nF,10%,16V,X7R,TP,1608
2203-005005	C9562	C-CERAMIC,CHIP	100nF,10%,16V,X7R,TP,1608
2203-005005	C9563	C-CERAMIC,CHIP	100nF,10%,16V,X7R,TP,1608
2203-005005	C9585	C-CERAMIC,CHIP	100nF,10%,16V,X7R,TP,1608
2203-005005	C9587	C-CERAMIC,CHIP	100nF,10%,16V,X7R,TP,1608
2203-005005	C9588	C-CERAMIC,CHIP	100nF,10%,16V,X7R,TP,1608
2203-005005	C9589	C-CERAMIC,CHIP	100nF,10%,16V,X7R,TP,1608
2203-005005	C9590	C-CERAMIC,CHIP	100nF,10%,16V,X7R,TP,1608
2203-005005	C9591	C-CERAMIC,CHIP	100nF,10%,16V,X7R,TP,1608
2203-005005	C9592	C-CERAMIC,CHIP	100nF,10%,16V,X7R,TP,1608
2203-005005	U118	C-CERAMIC,CHIP	100nF,10%,16V,X7R,TP,1608
2203-005005	U124	C-CERAMIC,CHIP	100nF,10%,16V,X7R,TP,1608
2203-005005	U125	C-CERAMIC,CHIP	100nF,10%,16V,X7R,TP,1608
2203-005005	U126	C-CERAMIC,CHIP	100nF,10%,16V,X7R,TP,1608
2203-005065	C261	C-CERAMIC,CHIP	1000nF,+80-20%,10V,Y5V,TP,1608
2203-005065	C264	C-CERAMIC,CHIP	1000nF,+80-20%,10V,Y5V,TP,1608
2203-005065	C988	C-CERAMIC,CHIP	1000nF,+80-20%,10V,Y5V,TP,1608
2203-005065	C989	C-CERAMIC,CHIP	1000nF,+80-20%,10V,Y5V,TP,1608
2203-006017	C221	C-CERAMIC,CHIP	0.56NF,5%,50V,COG,TP,1608
2203-006017	C224	C-CERAMIC,CHIP	0.56NF,5%,50V,COG,TP,1608
2402-000108	C3405	C-AL,SMD	10uF,20%,16V,WT,TP,4.3x4.3x5.4
2402-000108	C3406	C-AL,SMD	10uF,20%,16V,WT,TP,4.3x4.3x5.4
2402-000108	C3407	C-AL,SMD	10uF,20%,16V,WT,TP,4.3x4.3x5.4
2402-000108	C488	C-AL,SMD	10uF,20%,16V,WT,TP,4.3x4.3x5.4
2402-000108	C489	C-AL,SMD	10uF,20%,16V,WT,TP,4.3x4.3x5.4
2402-000108	C491	C-AL,SMD	10uF,20%,16V,WT,TP,4.3x4.3x5.4
2402-000108	C552	C-AL,SMD	10uF,20%,16V,WT,TP,4.3x4.3x5.4

2402-000108	C561	C-AL, SMD	10uF, 20%, 16V, WT, TP, 4. 3x4. 3x5. 4
2402-000108	C622	C-AL, SMD	10uF, 20%, 16V, WT, TP, 4. 3x4. 3x5. 4
2402-000135	C218	C-AL, SMD	22uF, 20%, 16V, GP, TP, 5. 3x5. 3x5. 4
2402-000135	C223	C-AL, SMD	22uF, 20%, 16V, GP, TP, 5. 3x5. 3x5. 4
2402-000135	C236	C-AL, SMD	22uF, 20%, 16V, GP, TP, 5. 3x5. 3x5. 4
2402-000135	C250	C-AL, SMD	22uF, 20%, 16V, GP, TP, 5. 3x5. 3x5. 4
2402-000135	C251	C-AL, SMD	22uF, 20%, 16V, GP, TP, 5. 3x5. 3x5. 4
2402-000135	C252	C-AL, SMD	22uF, 20%, 16V, GP, TP, 5. 3x5. 3x5. 4
2402-000135	C254	C-AL, SMD	22uF, 20%, 16V, GP, TP, 5. 3x5. 3x5. 4
2402-000135	C258	C-AL, SMD	22uF, 20%, 16V, GP, TP, 5. 3x5. 3x5. 4
2402-000135	C269	C-AL, SMD	22uF, 20%, 16V, GP, TP, 5. 3x5. 3x5. 4
2402-000135	C339	C-AL, SMD	22uF, 20%, 16V, GP, TP, 5. 3x5. 3x5. 4
2402-000135	C345	C-AL, SMD	22uF, 20%, 16V, GP, TP, 5. 3x5. 3x5. 4
2402-000135	C411	C-AL, SMD	22uF, 20%, 16V, GP, TP, 5. 3x5. 3x5. 4
2402-000135	C575	C-AL, SMD	22uF, 20%, 16V, GP, TP, 5. 3x5. 3x5. 4
2402-000135	C828	C-AL, SMD	22uF, 20%, 16V, GP, TP, 5. 3x5. 3x5. 4
2402-000135	C904	C-AL, SMD	22uF, 20%, 16V, GP, TP, 5. 3x5. 3x5. 4
2402-000135	C906	C-AL, SMD	22uF, 20%, 16V, GP, TP, 5. 3x5. 3x5. 4
2402-000135	C907	C-AL, SMD	22uF, 20%, 16V, GP, TP, 5. 3x5. 3x5. 4
2402-000135	C9556	C-AL, SMD	22uF, 20%, 16V, GP, TP, 5. 3x5. 3x5. 4
2402-000135	C9557	C-AL, SMD	22uF, 20%, 16V, GP, TP, 5. 3x5. 3x5. 4
2402-000135	C9558	C-AL, SMD	22uF, 20%, 16V, GP, TP, 5. 3x5. 3x5. 4
2402-000135	U120	C-AL, SMD	22uF, 20%, 16V, GP, TP, 5. 3x5. 3x5. 4
2402-000135	U121	C-AL, SMD	22uF, 20%, 16V, GP, TP, 5. 3x5. 3x5. 4
2402-000170	C3404	C-AL, SMD	1uF, 20%, 50V, GP, TP, 4. 3x4. 3x5. 4,
2402-000170	C343	C-AL, SMD	1uF, 20%, 50V, GP, TP, 4. 3x4. 3x5. 4,
2402-000170	C346	C-AL, SMD	1uF, 20%, 50V, GP, TP, 4. 3x4. 3x5. 4,
2402-000170	C350	C-AL, SMD	1uF, 20%, 50V, GP, TP, 4. 3x4. 3x5. 4,
2402-000170	C351	C-AL, SMD	1uF, 20%, 50V, GP, TP, 4. 3x4. 3x5. 4,
2402-000170	C358	C-AL, SMD	1uF, 20%, 50V, GP, TP, 4. 3x4. 3x5. 4,
2402-000170	C503	C-AL, SMD	1uF, 20%, 50V, GP, TP, 4. 3x4. 3x5. 4,
2402-000170	C612	C-AL, SMD	1uF, 20%, 50V, GP, TP, 4. 3x4. 3x5. 4,
2402-000170	C870	C-AL, SMD	1uF, 20%, 50V, GP, TP, 4. 3x4. 3x5. 4,
2402-000170	U116	C-AL, SMD	1uF, 20%, 50V, GP, TP, 4. 3x4. 3x5. 4,
2402-000173	C553	C-AL, SMD	4. 7uF, 20%, 35V, GP, TP, 4. 3x4. 3x5.
2402-000173	C554	C-AL, SMD	4. 7uF, 20%, 35V, GP, TP, 4. 3x4. 3x5.
2402-000173	C555	C-AL, SMD	4. 7uF, 20%, 35V, GP, TP, 4. 3x4. 3x5.
2402-000173	C556	C-AL, SMD	4. 7uF, 20%, 35V, GP, TP, 4. 3x4. 3x5.
2402-000173	C557	C-AL, SMD	4. 7uF, 20%, 35V, GP, TP, 4. 3x4. 3x5.
2402-000173	C563	C-AL, SMD	4. 7uF, 20%, 35V, GP, TP, 4. 3x4. 3x5.
2402-000173	C564	C-AL, SMD	4. 7uF, 20%, 35V, GP, TP, 4. 3x4. 3x5.
2402-000176	C502	C-AL, SMD	10uF, 20%, 16V, GP, TP, 4. 3x4. 3x5. 4
2402-000176	C545	C-AL, SMD	10uF, 20%, 16V, GP, TP, 4. 3x4. 3x5. 4
2402-000176	C546	C-AL, SMD	10uF, 20%, 16V, GP, TP, 4. 3x4. 3x5. 4
2402-000176	C566	C-AL, SMD	10uF, 20%, 16V, GP, TP, 4. 3x4. 3x5. 4
2402-000179	C311	C-AL, SMD	47uF, 20%, 16V, GP, TP, 6. 6x6. 6x5. 4
2402-000179	C497	C-AL, SMD	47uF, 20%, 16V, GP, TP, 6. 6x6. 6x5. 4
2402-000179	C577	C-AL, SMD	47uF, 20%, 16V, GP, TP, 6. 6x6. 6x5. 4
2402-000179	C603	C-AL, SMD	47uF, 20%, 16V, GP, TP, 6. 6x6. 6x5. 4
2402-000179	C611	C-AL, SMD	47uF, 20%, 16V, GP, TP, 6. 6x6. 6x5. 4
2402-000179	C9559	C-AL, SMD	47uF, 20%, 16V, GP, TP, 6. 6x6. 6x5. 4
2402-000209	C231	C-AL, SMD	22uF, 20%, 16V, WT, TP, 5. 3x5. 3mm, 1
2402-000209	C241	C-AL, SMD	22uF, 20%, 16V, WT, TP, 5. 3x5. 3mm, 1
2402-000209	C284	C-AL, SMD	22uF, 20%, 16V, WT, TP, 5. 3x5. 3mm, 1
2402-000209	C285	C-AL, SMD	22uF, 20%, 16V, WT, TP, 5. 3x5. 3mm, 1
2402-000209	C903	C-AL, SMD	22uF, 20%, 16V, WT, TP, 5. 3x5. 3mm, 1
2402-000209	C916	C-AL, SMD	22uF, 20%, 16V, WT, TP, 5. 3x5. 3mm, 1
2402-000209	C9560	C-AL, SMD	22uF, 20%, 16V, WT, TP, 5. 3x5. 3mm, 1
2402-001018	C504	C-AL, SMD	470nF, 20%, 50V, GP, TP, 4. 3x4. 3x5.

2402-001018	C505	C-AL,SMD	470nF,20%,50V,GP,TP,4.3x4.3x5.
2402-001019	C616	C-AL,SMD	2.2uF,20%,35V,GP,TP,3.3x3.3x5.
2402-001042	C041	C-AL,SMD	100uF,20%,16V,GP,TP,6.6x6.6x5.4mm
2402-001042	C247	C-AL,SMD	100uF,20%,16V,GP,TP,6.6x6.6x5.4mm
2402-001042	C281	C-AL,SMD	100uF,20%,16V,GP,TP,6.6x6.6x5.4mm
2402-001042	C336	C-AL,SMD	100uF,20%,16V,GP,TP,6.6x6.6x5.4mm
2402-001042	C382	C-AL,SMD	100uF,20%,16V,GP,TP,6.6x6.6x5.4mm
2402-001042	C392	C-AL,SMD	100uF,20%,16V,GP,TP,6.6x6.6x5.4mm
2402-001042	C405	C-AL,SMD	100uF,20%,16V,GP,TP,6.6x6.6x5.4mm
2402-001042	C535	C-AL,SMD	100uF,20%,16V,GP,TP,6.6x6.6x5.4mm
2402-001042	C604	C-AL,SMD	100uF,20%,16V,GP,TP,6.6x6.6x5.4mm
2402-001042	C621	C-AL,SMD	100uF,20%,16V,GP,TP,6.6x6.6x5.4mm
2402-001042	C809	C-AL,SMD	100uF,20%,16V,GP,TP,6.6x6.6x5.4mm
2402-001042	C847	C-AL,SMD	100uF,20%,16V,GP,TP,6.6x6.6x5.4mm
2402-001042	C861	C-AL,SMD	100uF,20%,16V,GP,TP,6.6x6.6x5.4mm
2402-001042	C891	C-AL,SMD	100uF,20%,16V,GP,TP,6.6x6.6x5.4mm
2402-001042	C892	C-AL,SMD	100uF,20%,16V,GP,TP,6.6x6.6x5.4mm
2402-001042	C895	C-AL,SMD	100uF,20%,16V,GP,TP,6.6x6.6x5.4mm
2402-001042	U127	C-AL,SMD	100uF,20%,16V,GP,TP,6.6x6.6x5.4mm
2402-001086	C9567	C-AL,SMD	100UF,20%,16V,WT,TP,6.6X6.6X5.3
2402-001086	U128	C-AL,SMD	100UF,20%,16V,WT,TP,6.6X6.6X5.3
2402-001128	C845	C-AL,SMD	100UF,20%,16V,WT,TP,6.3X5.7MM
2402-001128	C851	C-AL,SMD	100UF,20%,16V,WT,TP,6.3X5.7MM
2402-001128	C857	C-AL,SMD	100UF,20%,16V,WT,TP,6.3X5.7MM
2402-001128	C898	C-AL,SMD	100UF,20%,16V,WT,TP,6.3X5.7MM
2402-001155	C200	C-AL,SMD	47UF,20%,16V,WT,TP,6.3X5.2MM
2402-001155	C288	C-AL,SMD	47UF,20%,16V,WT,TP,6.3X5.2MM
2402-001155	C289	C-AL,SMD	47UF,20%,16V,WT,TP,6.3X5.2MM
2402-001155	C329	C-AL,SMD	47UF,20%,16V,WT,TP,6.3X5.2MM
2409-001046	C816	C-ORGANIC	39UF,20%,16V,WT,TP,6.3X6 MM,-
2409-001049	C810	C-ORGANIC	47UF,20%,6.3V,FX,TP,5X5.9MM,-
2409-001049	C813	C-ORGANIC	47UF,20%,6.3V,FX,TP,5X5.9MM,-
2409-001049	C815	C-ORGANIC	47UF,20%,6.3V,FX,TP,5X5.9MM,-
2409-001049	C818	C-ORGANIC	47UF,20%,6.3V,FX,TP,5X5.9MM,-
2409-001049	C827	C-ORGANIC	47UF,20%,6.3V,FX,TP,5X5.9MM,-
2409-001049	C865	C-ORGANIC	47UF,20%,6.3V,FX,TP,5X5.9MM,-
2409-001049	C867	C-ORGANIC	47UF,20%,6.3V,FX,TP,5X5.9MM,-
2409-001049	C869	C-ORGANIC	47UF,20%,6.3V,FX,TP,5X5.9MM,-
2409-001049	C876	C-ORGANIC	47UF,20%,6.3V,FX,TP,5X5.9MM,-
2409-001049	C890	C-ORGANIC	47UF,20%,6.3V,FX,TP,5X5.9MM,-
2409-001049	U129	C-ORGANIC	47UF,20%,6.3V,FX,TP,5X5.9MM,-
2503-001018	CA300	C-NETWORK	15PFX4,10%,50V,-
2503-001018	CA301	C-NETWORK	15PFX4,10%,50V,-
2503-001018	CA302	C-NETWORK	15PFX4,10%,50V,-
2503-001018	CA303	C-NETWORK	15PFX4,10%,50V,-
2503-001018	CA304	C-NETWORK	15PFX4,10%,50V,-
2503-001018	CA305	C-NETWORK	15PFX4,10%,50V,-
2703-000398	L008	INDUCTOR-SMD	10uH,10%,3.2x2.5x2.2mm
2703-001778	L201	INDUCTOR-SMD	3.3UH,20%,3.2X2.5X2.2MM
2703-001778	L202	INDUCTOR-SMD	3.3UH,20%,3.2X2.5X2.2MM
2703-001778	L203	INDUCTOR-SMD	3.3UH,20%,3.2X2.5X2.2MM
2703-001778	L204	INDUCTOR-SMD	3.3UH,20%,3.2X2.5X2.2MM
2703-001778	L205	INDUCTOR-SMD	3.3UH,20%,3.2X2.5X2.2MM
2703-001778	L206	INDUCTOR-SMD	3.3UH,20%,3.2X2.5X2.2MM
2703-001778	L207	INDUCTOR-SMD	3.3UH,20%,3.2X2.5X2.2MM
2703-001778	L208	INDUCTOR-SMD	3.3UH,20%,3.2X2.5X2.2MM
2703-001778	L301	INDUCTOR-SMD	3.3UH,20%,3.2X2.5X2.2MM
2703-001778	L555	INDUCTOR-SMD	3.3UH,20%,3.2X2.5X2.2MM
2703-002327	L540	INDUCTOR-SMD	3.9UH,55,3.2X2.5X2.2MM

2703-002327	L541	INDUCTOR-SMD	3.9UH,55,3.2X2.5X2.2MM	
2704-000001	FT925	INDUCTOR-SMD-ARRAY	4000HM,50V,0.5A,-,0.30HM,-25T085C	
2704-000001	FT926	INDUCTOR-SMD-ARRAY	4000HM,50V,0.5A,-,0.30HM,-25T085C	
2704-000001	FT933	INDUCTOR-SMD-ARRAY	4000HM,50V,0.5A,-,0.30HM,-25T085C	
2704-000001	FT934	INDUCTOR-SMD-ARRAY	4000HM,50V,0.5A,-,0.30HM,-25T085C	
2704-000004	FT935	INDUCTOR-SMD-ARRAY	2000HM,50V,0.5A,-,0.20HM,-25CT0+85C	
2801-003667	X201	CRYSTAL-SMD	14.3182MHZ,50PPM,28-AAN,16,500HM,TP	
2801-003843	X511	CRYSTAL-SMD	18.432MHz,30ppm,28-AAN,20pF,50ohm,TP	
2801-004117	X601	CRYSTAL-SMD	6MHZ,30PPM,28-ABX,20PF,1500HM,TP	
2901-001114	F187	FILTER-EMI SMD	25VDC,2.0ADC,-,100nF,3.2x1.6x1	
2901-001114	FT214	FILTER-EMI SMD	25VDC,2.0ADC,-,100nF,3.2x1.6x1	
2901-001114	FT281	FILTER-EMI SMD	25VDC,2.0ADC,-,100nF,3.2x1.6x1	
2901-001114	FT401	FILTER-EMI SMD	25VDC,2.0ADC,-,100nF,3.2x1.6x1	
2901-001114	FT901	FILTER-EMI SMD	25VDC,2.0ADC,-,100nF,3.2x1.6x1	
2901-001114	FT902	FILTER-EMI SMD	25VDC,2.0ADC,-,100nF,3.2x1.6x1	
2901-001114	FT903	FILTER-EMI SMD	25VDC,2.0ADC,-,100nF,3.2x1.6x1	
2901-001114	FT904	FILTER-EMI SMD	25VDC,2.0ADC,-,100nF,3.2x1.6x1	
2901-001114	FT923	FILTER-EMI SMD	25VDC,2.0ADC,-,100nF,3.2x1.6x1	
2901-001114	FT924	FILTER-EMI SMD	25VDC,2.0ADC,-,100nF,3.2x1.6x1	
3301-001145	FT201	CORE-FERRITE BEAD	AB,4.5x1.6x1.6mm,-,-	SNA
3301-001145	FT206	CORE-FERRITE BEAD	AB,4.5x1.6x1.6mm,-,-	SNA
3301-001145	FT210	CORE-FERRITE BEAD	AB,4.5x1.6x1.6mm,-,-	SNA
3301-001145	FT211	CORE-FERRITE BEAD	AB,4.5x1.6x1.6mm,-,-	SNA
3301-001145	FT304	CORE-FERRITE BEAD	AB,4.5x1.6x1.6mm,-,-	SNA
3301-001145	FT812	CORE-FERRITE BEAD	AB,4.5x1.6x1.6mm,-,-	SNA
3301-001145	FT813	CORE-FERRITE BEAD	AB,4.5x1.6x1.6mm,-,-	SNA
3301-001145	FT814	CORE-FERRITE BEAD	AB,4.5x1.6x1.6mm,-,-	SNA
3301-001145	FT815	CORE-FERRITE BEAD	AB,4.5x1.6x1.6mm,-,-	SNA
3301-001145	FT816	CORE-FERRITE BEAD	AB,4.5x1.6x1.6mm,-,-	SNA
3301-001145	FT817	CORE-FERRITE BEAD	AB,4.5x1.6x1.6mm,-,-	SNA
3301-001145	FT818	CORE-FERRITE BEAD	AB,4.5x1.6x1.6mm,-,-	SNA
3301-001145	FT821	CORE-FERRITE BEAD	AB,4.5x1.6x1.6mm,-,-	SNA
3301-001145	FT822	CORE-FERRITE BEAD	AB,4.5x1.6x1.6mm,-,-	SNA
3301-001145	FT824	CORE-FERRITE BEAD	AB,4.5x1.6x1.6mm,-,-	SNA
3301-001145	FT825	CORE-FERRITE BEAD	AB,4.5x1.6x1.6mm,-,-	SNA
3301-001145	FT851	CORE-FERRITE BEAD	AB,4.5x1.6x1.6mm,-,-	SNA
3301-001145	FT852	CORE-FERRITE BEAD	AB,4.5x1.6x1.6mm,-,-	SNA
3301-001145	FT877	CORE-FERRITE BEAD	AB,4.5x1.6x1.6mm,-,-	SNA
3301-001145	FT878	CORE-FERRITE BEAD	AB,4.5x1.6x1.6mm,-,-	SNA
3301-001145	FT927	CORE-FERRITE BEAD	AB,4.5x1.6x1.6mm,-,-	SNA
3301-001145	U130	CORE-FERRITE BEAD	AB,4.5x1.6x1.6mm,-,-	SNA
3301-001605	FT928	CORE-FERRITE BEAD	AB,3600HM,2.0X1.2X1.2MM,100MA,TP,FERRITE,0.50HM	SNA
3301-001605	FT929	CORE-FERRITE BEAD	AB,3600HM,2.0X1.2X1.2MM,100MA,TP,FERRITE,0.50HM	SNA
3301-001605	FT930	CORE-FERRITE BEAD	AB,3600HM,2.0X1.2X1.2MM,100MA,TP,FERRITE,0.50HM	SNA
3301-001605	FT931	CORE-FERRITE BEAD	AB,3600HM,2.0X1.2X1.2MM,100MA,TP,FERRITE,0.50HM	SNA
3301-001605	FT932	CORE-FERRITE BEAD	AB,3600HM,2.0X1.2X1.2MM,100MA,TP,FERRITE,0.50HM	SNA
3704-000249	IC620_SOCKET	SOCKET-IC	32P,PLCC,SN,1.27mm	
3711-000556	CN701	CONNECTOR-HEADER	BOX,12P,1R,1.25mm,SMD-A,SN	SNA
3711-000922	CN501	CONNECTOR-HEADER	BOX,4P,1R,1.25mm,SMD-A,SN	
3711-002046	CN512	CONNECTOR-HEADER	3WALL,12P,1R,1.25mm,SMD-S,SN	SNA
3711-002049	CN511	CONNECTOR-HEADER	BOX,6P,1R,1.25mm,SMD-A,SN	SNA
3711-002127	CN754	CONNECTOR-HEADER	BOX,8P,1R,1.25mm,SMD-A,SN	SNA
3711-003161	CN901	CONNECTOR-HEADER	BOX,20P,1R,1.25mm,ANGLE,SN	
3711-004130	CN575	CONNECTOR-HEADER	BOX,31P,2R,0.625mm,SMD-A,AUF	
3711-004933	CN502	CONNECTOR-HEADER	BOX,3P,1R,1.25MM,SMD-A,SN,WHT	SNA
3711-004933	CN706_1	CONNECTOR-HEADER	BOX,3P,1R,1.25MM,SMD-A,SN,WHT	SNA
3711-005154	CN505	CONNECTOR-HEADER	BOX,21P,2R,1.25MM,SMD-A,SN,20	SNA
BN27-00009A	L806	COIL CHOKE	SMD 12X12X6,EOS,33UH,15%,-,0.12 MAX,2A,DR10X5.0MM,18.5TS,12X12X6,1.8MM,1UEW 0.	
BN27-00010A	L801	COIL CHOKE	-,NK17NS,100UH,10%,-,0.7 MAX,6A,DR5.8X4.5MM,59.5TS,6.0X5.2X4.5MM,1.8MM,1UEW 0.	

BN27-00010A	L804	COIL CHOKE	-, NK17NS, 100UH, 10%, -, 0.7 MAX, 6A, DR5.8X4.5MM, 59.5TS, 6.0X5.2X4.5MM, 1.8MM, 1UEW 0.	
BN27-20001A	L807	COIL-CHOKE	-, 53.0UH, 20%, DR10*5, -, -, -, -, 0.18ohm, -, -, -, TRAY	
BN27-20001A	L818	COIL-CHOKE	-, 53.0UH, 20%, DR10*5, -, -, -, -, 0.18ohm, -, -, -, TRAY	
BN41-00169A	MP1.0	PCB MAIN	MB15NOA, FR4, 6L, 175X181X1.23, MB15NOA	SNA
BN91-00445A	-	ASSY SHIELD	MB15UO	SNA
6003-000117	SH/PCB+C/F	SCREW-TAPTITE	BH, +, B, M3, L6, ZPC (YEL), SWRCH18A	SNA
6003-000117	SH/PCB+IN/PCB	SCREW-TAPTITE	BH, +, B, M3, L6, ZPC (YEL), SWRCH18A	SNA
6003-000117	SH/PCB+M/PCB	SCREW-TAPTITE	BH, +, B, M3, L6, ZPC (YEL), SWRCH18A	SNA
BN02-00010A	CIS	TAPE ETC	MINERVA, AL-TAPE, 0.07MM, 60MM, 80MM, SILVER, DK-100-60-80	SNA
BN59-00289A	CIS	BOARD-INPUT ASS'Y	MB15UO, INPUT ASS'Y	SNA
BN63-00440A	CIS	FELT-SPACER	MB15KO, FELT, TO.35, 10, 71.5, BLK	SNA
BN63-00440B	CIS	FELT-SPACER	MB15KO, FELT, TO.35, 10, 187, BLK	SNA
BN63-00495A	CIS	GASKET	MINERVA, CONDUCTIVE FABRIC, 0.13MM, 80MM, 80MM, GRAY, DK-K102-80-80, CONDUCTIVE TAPE	SNA
BN90-00256A	CIS	ASSY SHIELD-PCB	RB15, -, SECC TO.5, -, -, -, -	SNA
BN63-00177A	CIS	SHIELD-PCB	RB15, SECC, TO.5, -, -, -, -	SNA
BN71-00022A	CIS	EARTH PLATE	RB15AS, SUS, TO.15	SNA
BN91-00567E	-	ASSY LCD	MB15"	SNA
BN07-00091A	CIS	LCD	LTM150XH-L06, CZB, 6BIT_ FRC, 331.6*254.76*12.5, 16.19M, -, 0.297*0.297, -, -, AMLCD/1 LV	
BN92-00436A	-	ASSY BOX	MB15NO	SNA
BH68-00329A	CIS	LABEL BAR CODE	ALL, MPRII, DOM, EXPORT, ART-PAPER 90G, -, -, -, -, WHT, -, -	SNA
BH75-10529A	CIS	UNIT-HANDLE PACKING	LXA410TLMU, PE, -, WHITE, -	SNA
BN72-60001A	CIS	LEVER TOP	LSD210TL, PE-LD, WHITE, TFT_LCD	SNA
BN72-60002A	CIS	LEVER BOTTOM	LSD210TL, PE-LD, WHITE, TFT-LCD	SNA
BN69-00341B	CIS	BOX	LYM1525, ADC, CB-SW4, YEL, A-1, L523*W415*H90	SNA
BN92-00437A	-	ASSY LABEL	MB15NO	SNA
BN68-00267A	CIS	LABEL RATING	MB15UO, ADC, PE, TO.05, 65, 79, PE NATURE	SNA
BN92-00439A	-	ASSY P/MATERIAL	MB15NO	SNA
0203-001100	CIS	TAPE-OPP MASKING	OPP/W75/CLR, TO.05, W75, L800000, CLR	SNA
BH69-00256C	CIS	PAD-PACKING-EDGE	MV940, B400, W200, L2030, -, -, YEL, -, -	SNA
BH69-00260A	CIS	BAG AIR	DP17L, PE, 0.2, 1800, 1000, NATURAL, -	SNA
BH69-30002C	CIS	BAG-PE	LDPE, TO.05, W2400, NO_PRINT	SNA
BH69-30348C	CIS	BAG-PE	HDPE, TO.02, W350*L430, Y, -, CGB51	SNA
BH69-30355E	CIS	BAG-PE/N	NK15, PE FOAM, 0.5, 650, 650, NTR	SNA
BH69-30360A	CIS	BAG-AIR	HDPE, TO.2, W1000*L1800, N, -, ALL	SNA
BH69-40380A	CIS	PACKING-PAD	DW-2, 500X2200X200, -, CGK5527	SNA
BN69-00274A	CIS	CUSHION	RB15, EPS, -, -, -, -, M50	SNA
BN69-00293F	CIS	PALLET-PACKING	MB15, STEEL, 1290, 1080, 100	SNA
BN92-00578Z	-	ASSY ACCESSORY	LTM1525X/XAA, SEA, UNITED STATES	SNA
BN59-00224B	CIS	REMOCON	, TM71, NIKE, 42, GR20, NTSC, EX	
BN96-00145Z	CIS	ASSY ACCESSORY	LTM1525X/XAA, SEA, UNITED STATES	
0203-000214	CIS	TAPE-OPP MASKING	OPP/W50/CLR, TO.05, W50, L400000,	SNA
4301-000121	CIS	BATTERY-MN	1.5V, -, AAA, 10.5x44.5m, HOLDER	SNA
BH39-10339X	CIS	CBF POWER CORD	DET, SVT, 125V/7A, BLK, 1830, WALL (ST), MSP-33, MSC-30	
BH39-40355W	CIS	CBF-HARNESS	-, 2000MM, IVORY, -, -, -	
BH69-30348D	CIS	BAG-PE	LDPE, TO.05, W240*L356, Y, -, CMG73	SNA
BN39-00043A	CIS	CBF SIGNAL	DETACHABLE, -, 15P/15P, -, -, -	
BN96-00159A	CIS	ASSY ACCESSORY	LTM1525X/XAA, SEA, UNITED STATES	
0203-000214	CIS	TAPE-OPP MASKING	OPP/W50/CLR, TO.05, W50, L400000,	SNA
AA68-00371C	CIS	CARD WARRANTY-01	, SEA, W/P100(G), 1 YEAR	SNA
BH68-00261P	CIS	MANUAL-00	SEAREGISTRATION CARD, SEA, E, USA, MOJO120G, 173, 234	SNA
BH69-30348D	CIS	BAG-PE	LDPE, TO.05, W240*L356, Y, -, CMG73	SNA
BN68-00281A	CIS	MANUAL USERS	LTM1525, SAMSUNG, E/F/S/P, ADC, MOJO100G	
S3-LTM1525X/XAA	-	4	LTM150XH-L06 ZPD	-
BN90-00297A	-	ASSY COVER REAR	MB15UO	SNA
6003-001246	C/F+C/R	SCREW-TAPTITE	FH, +, B, M3, L10, NI PLT, SWRCH18A	SNA
BN96-00038B	CIS	ASSY COVER P-REAR	MB15UO, USA, ABS HB, SVM-1207	
BN61-00092A	CIS	BRACKET-PIN	RB15, CU+ZN, TO.23, 35MM	Page 30
BN63-00173A	CIS	COVER-REAR	RB15, ABS, -, -, -, HB, -, BK08, SILVER SPRAY	SNA
BN63-00199A	CIS	COVER-HANDLE	RB15, ABS, HB, BK08, HB, 1.5	SNA

BN90-00318A	-	ASSY STAND	MB15NO	SNA
BN90-00257A	C1S	ASSY STAND	RB15, -, ABD HB, -, -, -, -, -	
6001-001612	C1S	SCREW-MACHINE	CH, +, M2, L3.5, ZPC (BLK), SWRCH18A, FP, -	
6003-001347	C1S	SCREW-TAPTITE	FH, +, B, M4, L16, ZPC (YEL), SWRCH18A, -	SNA
BN61-00158A	C1S	BRACKET-STAND	MINERVA, STS 420J2, T2.0	SNA
BN63-00176A	C1S	COVER-STAND	RB15, ABS, -, -, -, HB, -, BK08, HB, 1.5	SNA
BN73-60002A	C1S	RUBBER-FOOT	CY15PO, SPONGE, -, -, -, BL, -, -, -, -	SNA
BN90-00258A	C1S	ASSY HINGE	RB15, -, AL, -, -, -, -, DIE-CASTING	SNA
BN90-00341A	-	ASSY COVER FRONT	MB15UO	SNA
BN90-00255C	C1S	ASSY COVER FRONT	MB15UO, USA, ABS VO, SVM-1207	
6003-000259	C1S	SCREW-TAPTITE	BH, +, B, M3, L8, ZPC (YEL), SWRCH18A	SNA
BN59-00282A	C1S	SPEAKER SYSTEM	MINERVA, MINERVA-R, 3W, 46X46X20, 3W 40HM, WIRE:395MM	
BN59-00283A	C1S	SPEAKER SYSTEM	MINERVA, MINERVA-L, 3W, 46X46X20, 3W 40HM, WIRE:110MM	
BN59-00287A	C1S	BOARD-FUNCTION ASS'Y	MB15UO, CT5000-0610, FUNCTION ASS'Y	SNA
BN59-00288A	C1S	BOARD-PHONE JACK ASS'Y	MB15UO, CT5000-0620, PHONE-JACK ASS'Y	SNA
BN61-00082A	C1S	BRACKET-SPRING-STAND	RB15, SUS, T0.5, -, -, -, -	SNA
BN63-00172A	C1S	COVER-FRONT	RB15, ABS, -, -, -, HB, -, BK08, SILVER SPRAY	SNA
BN63-00175A	C1S	COVER-LENS	RB15, ABS, -, -, -, HB, -, IV16, NONE, 1.5	SNA
BN64-00031A	C1S	BADGE-BRAND	RB15AS, AL, T1.4, 6.3, 40.1, -, SILVER, -	SNA
BN64-00056A	C1S	KNOB-POWER	RB15, PC, -, -, -, HB, CLEAR, -, NI-CR	
BN64-00057A	C1S	KNOB-FUNCTION	RB15, ABS+PC, -, -, -, HB, BK08, -, NONE, 1.5	
BN67-00048A	C1S	LENS-IR	RB15, ACRYL, CLEAR, -, 1.5, -, HALF-MIRROR	SNA
BN67-00054A	C1S	LENS-LED	RB15, ACRYL, CLEAR, 1	
BN91-00310F	C1S	ASSY MISC	MB15	SNA
BN44-00063A	C1S	ADAPTOR	AD-4914N, EOS17, 100-240VAC, 47 - 63 HZ, +14VDC, 3.5A, -, 49W, -, 0 TO +40 C, 120*63*31, SA	
BN91-00394A	-	ASSY CHASSIS	MB15NO	
BN94-00309A	-	ASSY PCB MAIN	MB15NO	SNA
0201-001223	C1S	ADHESIVE-TS	HT-130S, RED, 700+/- 50, -	SNA
0202-001044	C1S	SOLDER-WIRE.	S63S-W3.0, S63S, D3, 63Sn/37Pb, -	SNA
0202-001046	C1S	SOLDER-WIRE FLUX	CF-110VH-2A, -, -, -, -	SNA
0202-001222	C1S	SOLDER-WIRE FLUX	RS-107, RS60-1.2AA, D1.2, SN60/PB40, -	SNA
0204-001095	C1S	THINNER	#4520, -, -, -	SNA
BH73-60304E	C1S	RUBBER-SUPPORT	MO15PS, CR VO, 6*6*6.4, BLACK	SNA
BN39-00161B	C1S	LEAD CONNECTOR-ASSY	MB15UO, UL1571#30, UL/CSA, 12P, #28, 12505HS-12, 12505HS-12, BK, 40MM, 1571#30, SJ02-01-05	
BN39-00272A	C1S	LEAD CONNECTOR-ASSY	MB15UO, UL1571#28, UL/CSA, 20P, #28, 12507HS-20, 12507HS-20, BK, 50MM, 1571#28, SJ01-01-40	
BN39-00275A	C1S	LEAD CONNECTOR-ASSY	MB15UO, UL1061#28, UL/CSA, 8P, #28, 12505HS-08, 12505HS-08, BK, 125MM, 1061#28, SJ02-01-06	
BN39-00287A	C1S	LEAD CONNECTOR-ASSY	MB15UO, UL1571#28, UL/CSA, 21P, #28, FI-W21S, FI-W21S, BK, 40MM, 1571#28, SJ01-01-405(1)	
BN39-00288A	C1S	LEAD CONNECTOR-ASSY	MB15UO, UL1571#28, UL/CSA, 31(25)P, #28, FI-W31S, FI-W31S, BK, 40MM, 1571#28, SJ01-01-405(
BN44-00061B	C1S	INVERTER	MB15UO, SIC540A, 48KHZ, 14VDC, 3.6MARMS, 6.8MARMS, 48KHZ, 140*65.5*7.0, 4LAMP, 48KHZ	
BN60-00011A	C1S	FASTENER-PEM/NUT	MINERVA, SUM24L (SN), M3, -, 7.0, 6.8, WHT	SNA
BN63-00174A	C1S	COVER-PCB	RB15, ABS, -, -, -, VO, -, IV16, TBBA, 1.5	SNA
BN63-00345A	C1S	SHIELD-SUB	MO15, SUS, T0.15	SNA
BN63-00413A	C1S	GASKET	MB15KO, CONDUCTIVE FABRIC, 5MM, 8MM, 8MM, GRAY, 71TSMK 8-5-8-13-D, 71TSMK 8-5-8-13-D	SNA
BN97-00096M	-	ASSY MICOM	MB15NO	
1102-001129	IC620	IC-EPROM	M27W401, 512KX8BIT, PLCC, 32P, 11.35X13.89MM, 80NS, 3.3V, 10%, PLASTIC, -40TO+85C, -, CMOS,	
BN46-00012J	C1S	S/W MICOM	MB15NO	SNA
BN97-00100A	-	ASSY SMD	MB15NO	SNA
0202-001162	C1S	SOLDER-CREAM	RMA-20-21L, S63, -, SN63/PB36.6/AGO.4, FLUX9.5%	SNA
0401-001056	D409	DIODE-SWITCHING	MMBD4148SE, 75V, 200MA, SOT-23, TP	
0401-001056	D410	DIODE-SWITCHING	MMBD4148SE, 75V, 200MA, SOT-23, TP	
0401-001056	D411	DIODE-SWITCHING	MMBD4148SE, 75V, 200MA, SOT-23, TP	
0401-001056	D681	DIODE-SWITCHING	MMBD4148SE, 75V, 200MA, SOT-23, TP	
0401-001056	D804	DIODE-SWITCHING	MMBD4148SE, 75V, 200MA, SOT-23, TP	
0402-000553	D802	DIODE-RECTIFIER	SS24, 40V, 2.0A, DO-214AA	
0402-000553	D875	DIODE-RECTIFIER	SS24, 40V, 2.0A, DO-214AA	
0402-001098	D803	DIODE-RECTIFIER	SK34, 40V, 3A, SMC, TP	
0403-000579	D601	DIODE-ZENER	BZX84C5V1, 5.1V, 5%, 200mW, SOT-23	
0403-000579	D602	DIODE-ZENER	BZX84C5V1, 5.1V, 5%, 200mW, SOT-23	
0403-000579	D604	DIODE-ZENER	BZX84C5V1, 5.1V, 5%, 200mW, SOT-23	

0403-001052	D543	DIODE-ZENER	RD8.2MB,8.2V,7.7-8.64V,200mW,S
0403-001052	D545	DIODE-ZENER	RD8.2MB,8.2V,7.7-8.64V,200mW,S
0403-001052	D876	DIODE-ZENER	RD8.2MB,8.2V,7.7-8.64V,200mW,S
0403-001052	D877	DIODE-ZENER	RD8.2MB,8.2V,7.7-8.64V,200mW,S
0404-001166	D805	DIODE-SCHOTTKY	MBRM130LT3,30V,1000MA,DO-216AA,TP
0404-001166	D806	DIODE-SCHOTTKY	MBRM130LT3,30V,1000MA,DO-216AA,TP
0501-000342	Q01	TR-SMALL SIGNAL	KSC1623-Y,NPN,200mW,SOT-23,TP,135-270
0501-000342	Q611	TR-SMALL SIGNAL	KSC1623-Y,NPN,200mW,SOT-23,TP,135-270
0501-002080	Q601	TR-SMALL SIGNAL	2SC2412K,NPN,200mW,SC-59,TP,120-270
0501-002080	Q610	TR-SMALL SIGNAL	2SC2412K,NPN,200mW,SC-59,TP,120-270
0501-002080	Q808	TR-SMALL SIGNAL	2SC2412K,NPN,200mW,SC-59,TP,120-270
0501-002080	Q809	TR-SMALL SIGNAL	2SC2412K,NPN,200mW,SC-59,TP,120-270
0501-002080	Q810	TR-SMALL SIGNAL	2SC2412K,NPN,200mW,SC-59,TP,120-270
0501-002080	Q811	TR-SMALL SIGNAL	2SC2412K,NPN,200mW,SC-59,TP,120-270
0501-002080	Q812	TR-SMALL SIGNAL	2SC2412K,NPN,200mW,SC-59,TP,120-270
0505-001170	IC808	FET-SILICON	SI9933ADY-T1,P,-20V,3.4A,0.06ohm,2W,SO-8
0801-002267	IC406	IC-CMOS LOGIC	74LCX14,-,SOIC,14P,150MIL,-,TP,-,-,3.6V,-40TO+85C,-,5.5V,-,24MA
0801-002547	IC408	IC-CMOS LOGIC	74VHC157,MULTIPLEXER,SOP,16P,150MIL,QUAD,TP,PLASTIC,-,0.36V,-40to+85C,-,1.5V,4
0904-001009	IC631	IC-I/O SUPPORT CHIP	8574A,-,SOP,16P,300MIL,100KHz,
0904-001009	IC632	IC-I/O SUPPORT CHIP	8574A,-,SOP,16P,300MIL,100KHz,
1001-001082	IC403	IC-VIDEO SWITCH	BA7657F,-,SOP,24P,300MIL,SINGL
1001-001109	IC681	IC-ANALOG SWITCH	FST3125M,BUS SWITCH & CMOS,SOIC,17P,150MIL,QUAD,7V,-40TO+85C,PLASTIC,-,4.00HM,5.
1002-001292	IC350	IC-A/D CONVERTER	AD9883AKST-110,8BITS,QFP,80P,551MIL,±0.5LSB,TR,CMOS,PLASTIC,3.3V,-25TO+85C,650M
1003-001419	IC300	IC-DISPLAY DRIVER	MN82860,QFP,208P,1102MIL,-,TR,PLASTIC,3.3V,-,2.3W,-,-
1103-000129	IC401	IC-EEPROM	24C02,256x8BIT,SOP,8P,150MIL,1
1103-000138	IC603	IC-EEPROM	24C16,2Kx8BIT,SOP,8P,150MIL,10
1109-001209	IC210	IC-GRAM	M32L32321SA,2X512KX32BIT,QFP,100P,-,7NS,3.3V,10%,PLASTIC,-55TO+150C,2MA,CMOS,TR
1109-001209	IC211	IC-GRAM	M32L32321SA,2X512KX32BIT,QFP,100P,-,7NS,3.3V,10%,PLASTIC,-55TO+150C,2MA,CMOS,TR
1201-001559	IC503	IC-AUDIO AMP	4863,TSSOP,20P,173MIL,DUAL,98dB,PLASTIC,5.5V,2.45W,-40to+85C,-,-,-,-
1203-000404	IC811	IC-DC/DC CONVERTER	34063,SOP,8P,150MIL,PLASTIC,1.0/1.3V,-,0TO+70C,4.0MA,-,ST
1203-000404	IC812	IC-DC/DC CONVERTER	34063,SOP,8P,150MIL,PLASTIC,1.0/1.3V,-,0TO+70C,4.0MA,-,ST
1203-001212	IC604	IC-VOL. DETECTOR	7029,SOT-89,3P,-,PLASTIC,-,500
1203-001293	IC301	IC-POSIFIXED REG.	033,TO-252,3P,6.5MIL,PLASTIC,3
1203-001293	IC813	IC-POSIFIXED REG.	033,TO-252,3P,6.5MIL,PLASTIC,3
1203-001448	IC804	IC-SWITCH VOL. REG.	2596,TO-263,5P,-,PLASTIC,4.750
1203-001448	IC807	IC-SWITCH VOL. REG.	2596,TO-263,5P,-,PLASTIC,4.750
1203-001816	IC803	IC-POSIFIXED REG.	78M08,TO-252,3P,-,PLASTIC,7.7/8.3V,1.0W,-40TO+85C,0.5A,-,TP
1203-001830	IC805	IC-SWITCH VOL. REG.	2676,TO-263,7P,-,PLASTIC,3.234/3.336V,-,40TO+125C,3A,-,TP
1203-001890	IC802	IC-VOLTAGE REGULATOR	3961,SOT223-5,5P,-,PLASTIC,2.5V,-,40to+125C,800mA,-,TR
1203-001890	IC806	IC-VOLTAGE REGULATOR	3961,SOT223-5,5P,-,PLASTIC,2.5V,-,40to+125C,800mA,-,TR
1204-001551	IC175	IC-VIDEO SYSTEM	GS1881,SOIC,8P,150MIL,PLASTIC,13.2V,-,0TO+70C,TP,VIDEO SYNC SEPARATOR
1204-001852	IC919	IC-SOUND PROCESSOR	MSP3421G-B8,PQFP,80P,-,PLASTIC,9V,1000MM,0TO70C,TR,-
1204-001911	IC200	IC-VIDEO PROCESS	DPTV-3D-6730,PQFP,208P,28X28MM,PLASTIC,4.6V,-,0TO+70C,TR,-
1204-001912	IC601	IC-DECODER	SDA5550M,P-MQFP,100P,-,PLASTIC,3.3V,1.5W,0TO+70C,TR,-
1205-001740	IC901	IC-TRANSMITTER	DS90C385,TSSOP,56P,240MIL,PLASTIC,4V,1.63W,-10 TO +70C,ST,FPD LINK-85MHZ(LVDS)
1206-000111	ICA5	IC-TIMER	KA555D/T.R,SOP,8P,150MIL,-,18V
2007-000052	R4564	R-CHIP	10Kohm,1%,1/16W,DA,TP,1608
2007-000052	R4565	R-CHIP	10Kohm,1%,1/16W,DA,TP,1608
2007-000052	R4566	R-CHIP	10Kohm,1%,1/16W,DA,TP,1608
2007-000052	R4567	R-CHIP	10Kohm,1%,1/16W,DA,TP,1608
2007-000052	RA0	R-CHIP	10Kohm,1%,1/16W,DA,TP,1608
2007-000070	R303	R-CHIP	0ohm,5%,1/16W,DA,TP,1608
2007-000070	R328	R-CHIP	0ohm,5%,1/16W,DA,TP,1608
2007-000070	R638	R-CHIP	0ohm,5%,1/16W,DA,TP,1608
2007-000070	R902	R-CHIP	0ohm,5%,1/16W,DA,TP,1608
2007-000071	R355	R-CHIP	22ohm,5%,1/16W,DA,TP,1608
2007-000071	R3590	R-CHIP	22ohm,5%,1/16W,DA,TP,1608
2007-000071	R367	R-CHIP	22ohm,5%,1/16W,DA,TP,1608
2007-000071	R630	R-CHIP	22ohm,5%,1/16W,DA,TP,1608

2007-000074	R683	R-CHIP	100ohm, 5%, 1/16W, DA, TP, 1608
2007-000074	R685	R-CHIP	100ohm, 5%, 1/16W, DA, TP, 1608
2007-000074	R686	R-CHIP	100ohm, 5%, 1/16W, DA, TP, 1608
2007-000074	R687	R-CHIP	100ohm, 5%, 1/16W, DA, TP, 1608
2007-000074	RA1	R-CHIP	100ohm, 5%, 1/16W, DA, TP, 1608
2007-000074	RA2	R-CHIP	100ohm, 5%, 1/16W, DA, TP, 1608
2007-000075	R639	R-CHIP	220ohm, 5%, 1/16W, DA, TP, 1608
2007-000075	R642	R-CHIP	220ohm, 5%, 1/16W, DA, TP, 1608
2007-000075	R651	R-CHIP	220ohm, 5%, 1/16W, DA, TP, 1608
2007-000075	R680	R-CHIP	220ohm, 5%, 1/16W, DA, TP, 1608
2007-000075	R682	R-CHIP	220ohm, 5%, 1/16W, DA, TP, 1608
2007-000075	RA3	R-CHIP	220ohm, 5%, 1/16W, DA, TP, 1608
2007-000076	R665	R-CHIP	330ohm, 5%, 1/16W, DA, TP, 1608
2007-000076	R666	R-CHIP	330ohm, 5%, 1/16W, DA, TP, 1608
2007-000076	R668	R-CHIP	330ohm, 5%, 1/16W, DA, TP, 1608
2007-000076	R671	R-CHIP	330ohm, 5%, 1/16W, DA, TP, 1608
2007-000076	R672	R-CHIP	330ohm, 5%, 1/16W, DA, TP, 1608
2007-000076	R673	R-CHIP	330ohm, 5%, 1/16W, DA, TP, 1608
2007-000077	R4005	R-CHIP	470ohm, 5%, 1/16W, DA, TP, 1608
2007-000077	R4009	R-CHIP	470ohm, 5%, 1/16W, DA, TP, 1608
2007-000077	R623	R-CHIP	470ohm, 5%, 1/16W, DA, TP, 1608
2007-000078	R505	R-CHIP	1Kohm, 5%, 1/16W, DA, TP, 1608
2007-000078	R506	R-CHIP	1Kohm, 5%, 1/16W, DA, TP, 1608
2007-000078	R509	R-CHIP	1Kohm, 5%, 1/16W, DA, TP, 1608
2007-000078	R510	R-CHIP	1Kohm, 5%, 1/16W, DA, TP, 1608
2007-000078	R516	R-CHIP	1Kohm, 5%, 1/16W, DA, TP, 1608
2007-000078	R517	R-CHIP	1Kohm, 5%, 1/16W, DA, TP, 1608
2007-000078	R520	R-CHIP	1Kohm, 5%, 1/16W, DA, TP, 1608
2007-000078	R521	R-CHIP	1Kohm, 5%, 1/16W, DA, TP, 1608
2007-000078	R522	R-CHIP	1Kohm, 5%, 1/16W, DA, TP, 1608
2007-000078	R529	R-CHIP	1Kohm, 5%, 1/16W, DA, TP, 1608
2007-000078	R531	R-CHIP	1Kohm, 5%, 1/16W, DA, TP, 1608
2007-000078	R604	R-CHIP	1Kohm, 5%, 1/16W, DA, TP, 1608
2007-000080	R807	R-CHIP	2Kohm, 5%, 1/16W, DA, TP, 1608
2007-000082	R356	R-CHIP	3.3Kohm, 5%, 1/16W, DA, TP, 1608
2007-000082	R4006	R-CHIP	3.3Kohm, 5%, 1/16W, DA, TP, 1608
2007-000082	R4010	R-CHIP	3.3Kohm, 5%, 1/16W, DA, TP, 1608
2007-000082	R4551	R-CHIP	3.3Kohm, 5%, 1/16W, DA, TP, 1608
2007-000084	R02	R-CHIP	4.7Kohm, 5%, 1/16W, DA, TP, 1608
2007-000084	R239	R-CHIP	4.7Kohm, 5%, 1/16W, DA, TP, 1608
2007-000084	R302	R-CHIP	4.7Kohm, 5%, 1/16W, DA, TP, 1608
2007-000084	R527	R-CHIP	4.7Kohm, 5%, 1/16W, DA, TP, 1608
2007-000084	R617	R-CHIP	4.7Kohm, 5%, 1/16W, DA, TP, 1608
2007-000084	R631	R-CHIP	4.7Kohm, 5%, 1/16W, DA, TP, 1608
2007-000084	R636	R-CHIP	4.7Kohm, 5%, 1/16W, DA, TP, 1608
2007-000084	R646	R-CHIP	4.7Kohm, 5%, 1/16W, DA, TP, 1608
2007-000084	R648	R-CHIP	4.7Kohm, 5%, 1/16W, DA, TP, 1608
2007-000084	R649	R-CHIP	4.7Kohm, 5%, 1/16W, DA, TP, 1608
2007-000084	R674	R-CHIP	4.7Kohm, 5%, 1/16W, DA, TP, 1608
2007-000084	R675	R-CHIP	4.7Kohm, 5%, 1/16W, DA, TP, 1608
2007-000084	R821	R-CHIP	4.7Kohm, 5%, 1/16W, DA, TP, 1608
2007-000084	R822	R-CHIP	4.7Kohm, 5%, 1/16W, DA, TP, 1608
2007-000084	R841	R-CHIP	4.7Kohm, 5%, 1/16W, DA, TP, 1608
2007-000084	R842	R-CHIP	4.7Kohm, 5%, 1/16W, DA, TP, 1608
2007-000084	R891	R-CHIP	4.7Kohm, 5%, 1/16W, DA, TP, 1608
2007-000090	R208	R-CHIP	10KOHM, 5%, 1/16W, DA, TP, 1608
2007-000090	R241	R-CHIP	10KOHM, 5%, 1/16W, DA, TP, 1608
2007-000090	R248	R-CHIP	10KOHM, 5%, 1/16W, DA, TP, 1608
2007-000090	R301	R-CHIP	10KOHM, 5%, 1/16W, DA, TP, 1608

2007-000090	R327	R-CHIP	10KOHM, 5%, 1/16W, DA, TP, 1608
2007-000090	R357	R-CHIP	10KOHM, 5%, 1/16W, DA, TP, 1608
2007-000090	R358	R-CHIP	10KOHM, 5%, 1/16W, DA, TP, 1608
2007-000090	R601	R-CHIP	10KOHM, 5%, 1/16W, DA, TP, 1608
2007-000090	R607	R-CHIP	10KOHM, 5%, 1/16W, DA, TP, 1608
2007-000090	R609	R-CHIP	10KOHM, 5%, 1/16W, DA, TP, 1608
2007-000090	R621	R-CHIP	10KOHM, 5%, 1/16W, DA, TP, 1608
2007-000090	R622	R-CHIP	10KOHM, 5%, 1/16W, DA, TP, 1608
2007-000090	R653	R-CHIP	10KOHM, 5%, 1/16W, DA, TP, 1608
2007-000090	R654	R-CHIP	10KOHM, 5%, 1/16W, DA, TP, 1608
2007-000090	R655	R-CHIP	10KOHM, 5%, 1/16W, DA, TP, 1608
2007-000090	R656	R-CHIP	10KOHM, 5%, 1/16W, DA, TP, 1608
2007-000090	R657	R-CHIP	10KOHM, 5%, 1/16W, DA, TP, 1608
2007-000090	R658	R-CHIP	10KOHM, 5%, 1/16W, DA, TP, 1608
2007-000090	R659	R-CHIP	10KOHM, 5%, 1/16W, DA, TP, 1608
2007-000090	R661	R-CHIP	10KOHM, 5%, 1/16W, DA, TP, 1608
2007-000090	R676	R-CHIP	10KOHM, 5%, 1/16W, DA, TP, 1608
2007-000090	R677	R-CHIP	10KOHM, 5%, 1/16W, DA, TP, 1608
2007-000090	R678	R-CHIP	10KOHM, 5%, 1/16W, DA, TP, 1608
2007-000090	R684	R-CHIP	10KOHM, 5%, 1/16W, DA, TP, 1608
2007-000090	R823	R-CHIP	10KOHM, 5%, 1/16W, DA, TP, 1608
2007-000090	R824	R-CHIP	10KOHM, 5%, 1/16W, DA, TP, 1608
2007-000090	R873	R-CHIP	10KOHM, 5%, 1/16W, DA, TP, 1608
2007-000091	R4560	R-CHIP	12Kohm, 5%, 1/16W, DA, TP, 1608
2007-000091	R4561	R-CHIP	12Kohm, 5%, 1/16W, DA, TP, 1608
2007-000091	R4562	R-CHIP	12Kohm, 5%, 1/16W, DA, TP, 1608
2007-000091	R4563	R-CHIP	12Kohm, 5%, 1/16W, DA, TP, 1608
2007-000092	R4568	R-CHIP	15Kohm, 5%, 1/16W, DA, TP, 1608
2007-000092	R4569	R-CHIP	15Kohm, 5%, 1/16W, DA, TP, 1608
2007-000093	R312	R-CHIP	20Kohm, 5%, 1/16W, DA, TP, 1608
2007-000097	R608	R-CHIP	47Kohm, 5%, 1/16W, DA, TP, 1608
2007-000098	R690	R-CHIP	56Kohm, 5%, 1/16W, DA, TP, 1608
2007-000102	R553	R-CHIP	100Kohm, 5%, 1/16W, DA, TP, 1608
2007-000102	R554	R-CHIP	100Kohm, 5%, 1/16W, DA, TP, 1608
2007-000102	R874	R-CHIP	100Kohm, 5%, 1/16W, DA, TP, 1608
2007-000107	R404	R-CHIP	470Kohm, 5%, 1/16W, DA, TP, 1608
2007-000109	R305	R-CHIP	1Mohm, 5%, 1/16W, DA, TP, 1608
2007-000109	R309	R-CHIP	1Mohm, 5%, 1/16W, DA, TP, 1608
2007-000109	R317	R-CHIP	1Mohm, 5%, 1/16W, DA, TP, 1608
2007-000113	R201	R-CHIP	33ohm, 5%, 1/16W, DA, TP, 1608
2007-000113	R202	R-CHIP	33ohm, 5%, 1/16W, DA, TP, 1608
2007-000113	R203	R-CHIP	33ohm, 5%, 1/16W, DA, TP, 1608
2007-000113	R204	R-CHIP	33ohm, 5%, 1/16W, DA, TP, 1608
2007-000113	R205	R-CHIP	33ohm, 5%, 1/16W, DA, TP, 1608
2007-000113	R206	R-CHIP	33ohm, 5%, 1/16W, DA, TP, 1608
2007-000113	R207	R-CHIP	33ohm, 5%, 1/16W, DA, TP, 1608
2007-000113	R219	R-CHIP	33ohm, 5%, 1/16W, DA, TP, 1608
2007-000116	R238	R-CHIP	120ohm, 5%, 1/16W, DA, TP, 1608
2007-000116	R4007	R-CHIP	120ohm, 5%, 1/16W, DA, TP, 1608
2007-000116	R906	R-CHIP	120ohm, 5%, 1/16W, DA, TP, 1608
2007-000118	R235	R-CHIP	390ohm, 5%, 1/16W, DA, TP, 1608
2007-000119	R4556	R-CHIP	560ohm, 5%, 1/16W, DA, TP, 1608
2007-000119	R4557	R-CHIP	560ohm, 5%, 1/16W, DA, TP, 1608
2007-000119	R4558	R-CHIP	560ohm, 5%, 1/16W, DA, TP, 1608
2007-000119	R4559	R-CHIP	560ohm, 5%, 1/16W, DA, TP, 1608
2007-000120	R645	R-CHIP	680ohm, 5%, 1/16W, DA, TP, 1608
2007-000123	R01	R-CHIP	1.5Kohm, 5%, 1/16W, DA, TP, 1608
2007-000124	R944	R-CHIP	2.2Kohm, 5%, 1/16W, DA, TP, 1608
2007-000134	R511	R-CHIP	33Kohm, 5%, 1/16W, DA, TP, 1608

2007-000134	R539	R-CHIP	33Kohm, 5%, 1/16W, DA, TP, 1608
2007-000219	R806	R-CHIP	1.2Kohm, 1%, 1/16W, DA, TP, 1608
2007-000219	R809	R-CHIP	1.2Kohm, 1%, 1/16W, DA, TP, 1608
2007-000239	R612	R-CHIP	1.5Kohm, 1%, 1/16W, DA, TP, 1608
2007-000239	R613	R-CHIP	1.5Kohm, 1%, 1/16W, DA, TP, 1608
2007-000309	R214	R-CHIP	10ohm, 5%, 1/16W, DA, TP, 1608
2007-000309	R215	R-CHIP	10ohm, 5%, 1/16W, DA, TP, 1608
2007-000309	R224	R-CHIP	10ohm, 5%, 1/16W, DA, TP, 1608
2007-000309	R692	R-CHIP	10ohm, 5%, 1/16W, DA, TP, 1608
2007-000309	R693	R-CHIP	10ohm, 5%, 1/16W, DA, TP, 1608
2007-000309	RJ15	R-CHIP	10ohm, 5%, 1/16W, DA, TP, 1608
2007-000309	RJ16	R-CHIP	10ohm, 5%, 1/16W, DA, TP, 1608
2007-000309	RJ17	R-CHIP	10ohm, 5%, 1/16W, DA, TP, 1608
2007-000402	R610	R-CHIP	150ohm, 5%, 1/16W, DA, TP, 1608
2007-000402	R611	R-CHIP	150ohm, 5%, 1/16W, DA, TP, 1608
2007-000402	R620	R-CHIP	150ohm, 5%, 1/16W, DA, TP, 1608
2007-000402	R943	R-CHIP	150ohm, 5%, 1/16W, DA, TP, 1608
2007-000616	R318	R-CHIP	24Kohm, 5%, 1/16W, DA, TP, 1608
2007-000701	R810	R-CHIP	3.6Kohm, 1%, 1/16W, DA, TP, 1608
2007-000882	R4571	R-CHIP	4.7ohm, 5%, 1/16W, DA, TP, 1608
2007-000882	R4572	R-CHIP	4.7ohm, 5%, 1/16W, DA, TP, 1608
2007-001039	R602	R-CHIP	56KOHM, 5%, 1/10W, DA, TP, 2012
2007-001114	R4008	R-CHIP	680Kohm, 5%, 1/16W, DA, TP, 1608
2007-001164	R307	R-CHIP	75ohm, 1%, 1/16W, DA, TP, 1608
2007-001164	R308	R-CHIP	75ohm, 1%, 1/16W, DA, TP, 1608
2007-001164	R310	R-CHIP	75ohm, 1%, 1/16W, DA, TP, 1608
2007-001164	R311	R-CHIP	75ohm, 1%, 1/16W, DA, TP, 1608
2007-001164	R313	R-CHIP	75ohm, 1%, 1/16W, DA, TP, 1608
2007-001164	R319	R-CHIP	75ohm, 1%, 1/16W, DA, TP, 1608
2007-001167	R236	R-CHIP	75ohm, 5%, 1/16W, DA, TP, 1608
2007-001167	R401	R-CHIP	75ohm, 5%, 1/16W, DA, TP, 1608
2007-001167	R402	R-CHIP	75ohm, 5%, 1/16W, DA, TP, 1608
2007-001167	R403	R-CHIP	75ohm, 5%, 1/16W, DA, TP, 1608
2007-001167	R619	R-CHIP	75ohm, 5%, 1/16W, DA, TP, 1608
2007-008433	R4570	R-CHIP	0.330HM, 1%, 1W, DA, TP, 6432
2007-008433	R805	R-CHIP	0.330HM, 1%, 1W, DA, TP, 6432
2007-008433	R808	R-CHIP	0.330HM, 1%, 1W, DA, TP, 6432
2011-000002	RA301	R-NETWORK	22ohm, 5%, 63mW, L, CHIP, 8P, TP
2011-000002	RA302	R-NETWORK	22ohm, 5%, 63mW, L, CHIP, 8P, TP
2011-000002	RA303	R-NETWORK	22ohm, 5%, 63mW, L, CHIP, 8P, TP
2011-000002	RA304	R-NETWORK	22ohm, 5%, 63mW, L, CHIP, 8P, TP
2011-000002	RA305	R-NETWORK	22ohm, 5%, 63mW, L, CHIP, 8P, TP
2011-000002	RA306	R-NETWORK	22ohm, 5%, 63mW, L, CHIP, 8P, TP
2011-000515	RA610	R-NETWORK	4.7Kohm, 5%, 1/16W, L, CHIP, 8P, TP
2011-000515	RA611	R-NETWORK	4.7Kohm, 5%, 1/16W, L, CHIP, 8P, TP
2011-000651	RA601	R-NETWORK	10ohm, 5%, 63mW, L, CHIP, 8P, TP
2011-000651	RA602	R-NETWORK	10ohm, 5%, 63mW, L, CHIP, 8P, TP
2011-000651	RA603	R-NETWORK	10ohm, 5%, 63mW, L, CHIP, 8P, TP
2011-000651	RA604	R-NETWORK	10ohm, 5%, 63mW, L, CHIP, 8P, TP
2011-000651	RA605	R-NETWORK	10ohm, 5%, 63mW, L, CHIP, 8P, TP
2011-000651	RA606	R-NETWORK	10ohm, 5%, 63mW, L, CHIP, 8P, TP
2011-000651	RA607	R-NETWORK	10ohm, 5%, 63mW, L, CHIP, 8P, TP
2011-000651	RA608	R-NETWORK	10ohm, 5%, 63mW, L, CHIP, 8P, TP
2011-000651	RA609	R-NETWORK	10ohm, 5%, 63mW, L, CHIP, 8P, TP
2203-000140	C538	C-CERAMIC, CHIP	1.5nF, 10%, 50V, X7R, TP, 1608, -
2203-000140	C574	C-CERAMIC, CHIP	1.5nF, 10%, 50V, X7R, TP, 1608, -
2203-000189	C338	C-CERAMIC, CHIP	100nF, +80-20%, 25V, Y5V, TP, 1608, -
2203-000189	C3503	C-CERAMIC, CHIP	100nF, +80-20%, 25V, Y5V, TP, 1608, -
2203-000189	C559	C-CERAMIC, CHIP	100nF, +80-20%, 25V, Y5V, TP, 1608, -

2203-000815	C454	C-CERAMIC,CHIP	0.033nF,5%,50V,NPO,TP,1608
2203-000815	C455	C-CERAMIC,CHIP	0.033nF,5%,50V,NPO,TP,1608
2203-000815	C456	C-CERAMIC,CHIP	0.033nF,5%,50V,NPO,TP,1608
2203-000815	C915	C-CERAMIC,CHIP	0.033nF,5%,50V,NPO,TP,1608
2203-000815	C9561	C-CERAMIC,CHIP	0.033nF,5%,50V,NPO,TP,1608
2203-000815	C9582	C-CERAMIC,CHIP	0.033nF,5%,50V,NPO,TP,1608
2203-000843	C379	C-CERAMIC,CHIP	39nF,10%,25V,X7R,TP,1608,-
2203-000972	C576	C-CERAMIC,CHIP	47nF,10%,16V,X7R,TP,1608
2203-000998	C306	C-CERAMIC,CHIP	0.047nF,5%,50V,NPO,TP,1608
2203-000998	C307	C-CERAMIC,CHIP	0.047nF,5%,50V,NPO,TP,1608
2203-000998	C3302	C-CERAMIC,CHIP	0.047nF,5%,50V,NPO,TP,1608
2203-001077	C567	C-CERAMIC,CHIP	0.056nF,5%,50V,NPO,TP,2012
2203-001077	C568	C-CERAMIC,CHIP	0.056nF,5%,50V,NPO,TP,2012
2203-001077	C571	C-CERAMIC,CHIP	0.056nF,5%,50V,NPO,TP,2012
2203-001077	C9572	C-CERAMIC,CHIP	0.056nF,5%,50V,NPO,TP,2012
2203-001077	C9573	C-CERAMIC,CHIP	0.056nF,5%,50V,NPO,TP,2012
2203-001077	C9574	C-CERAMIC,CHIP	0.056nF,5%,50V,NPO,TP,2012
2203-001077	C9575	C-CERAMIC,CHIP	0.056nF,5%,50V,NPO,TP,2012
2203-001607	C608	C-CERAMIC,CHIP	0.22nF,5%,50V,NPO,TP,1608
2203-001630	C9594	C-CERAMIC,CHIP	330nF,+80-20%,16V,Y5V,TP,1608
2203-001630	C9595	C-CERAMIC,CHIP	330nF,+80-20%,16V,Y5V,TP,1608
2203-001656	C404	C-CERAMIC,CHIP	0.47nF,5%,50V,NPO,TP,1608
2203-001656	C543	C-CERAMIC,CHIP	0.47nF,5%,50V,NPO,TP,1608
2203-001656	C569	C-CERAMIC,CHIP	0.47nF,5%,50V,NPO,TP,1608
2203-001656	C9564	C-CERAMIC,CHIP	0.47nF,5%,50V,NPO,TP,1608
2203-001656	C9565	C-CERAMIC,CHIP	0.47nF,5%,50V,NPO,TP,1608
2203-005005	C214	C-CERAMIC,CHIP	100nF,10%,16V,X7R,TP,1608
2203-005005	C215	C-CERAMIC,CHIP	100nF,10%,16V,X7R,TP,1608
2203-005005	C216	C-CERAMIC,CHIP	100nF,10%,16V,X7R,TP,1608
2203-005005	C217	C-CERAMIC,CHIP	100nF,10%,16V,X7R,TP,1608
2203-005005	C229	C-CERAMIC,CHIP	100nF,10%,16V,X7R,TP,1608
2203-005005	C238	C-CERAMIC,CHIP	100nF,10%,16V,X7R,TP,1608
2203-005005	C245	C-CERAMIC,CHIP	100nF,10%,16V,X7R,TP,1608
2203-005005	C249	C-CERAMIC,CHIP	100nF,10%,16V,X7R,TP,1608
2203-005005	C267	C-CERAMIC,CHIP	100nF,10%,16V,X7R,TP,1608
2203-005005	C274	C-CERAMIC,CHIP	100nF,10%,16V,X7R,TP,1608
2203-005005	C275	C-CERAMIC,CHIP	100nF,10%,16V,X7R,TP,1608
2203-005005	C276	C-CERAMIC,CHIP	100nF,10%,16V,X7R,TP,1608
2203-005005	C277	C-CERAMIC,CHIP	100nF,10%,16V,X7R,TP,1608
2203-005005	C278	C-CERAMIC,CHIP	100nF,10%,16V,X7R,TP,1608
2203-005005	C279	C-CERAMIC,CHIP	100nF,10%,16V,X7R,TP,1608
2203-005005	C282	C-CERAMIC,CHIP	100nF,10%,16V,X7R,TP,1608
2203-005005	C302	C-CERAMIC,CHIP	100nF,10%,16V,X7R,TP,1608
2203-005005	C303	C-CERAMIC,CHIP	100nF,10%,16V,X7R,TP,1608
2203-005005	C305	C-CERAMIC,CHIP	100nF,10%,16V,X7R,TP,1608
2203-005005	C318	C-CERAMIC,CHIP	100nF,10%,16V,X7R,TP,1608
2203-005005	C319	C-CERAMIC,CHIP	100nF,10%,16V,X7R,TP,1608
2203-005005	C321	C-CERAMIC,CHIP	100nF,10%,16V,X7R,TP,1608
2203-005005	C322	C-CERAMIC,CHIP	100nF,10%,16V,X7R,TP,1608
2203-005005	C323	C-CERAMIC,CHIP	100nF,10%,16V,X7R,TP,1608
2203-005005	C327	C-CERAMIC,CHIP	100nF,10%,16V,X7R,TP,1608
2203-005005	C328	C-CERAMIC,CHIP	100nF,10%,16V,X7R,TP,1608
2203-005005	C3303	C-CERAMIC,CHIP	100nF,10%,16V,X7R,TP,1608
2203-005005	C3304	C-CERAMIC,CHIP	100nF,10%,16V,X7R,TP,1608
2203-005005	C3305	C-CERAMIC,CHIP	100nF,10%,16V,X7R,TP,1608
2203-005005	C3306	C-CERAMIC,CHIP	100nF,10%,16V,X7R,TP,1608
2203-005005	C3307	C-CERAMIC,CHIP	100nF,10%,16V,X7R,TP,1608
2203-005005	C3308	C-CERAMIC,CHIP	100nF,10%,16V,X7R,TP,1608
2203-005005	C3309	C-CERAMIC,CHIP	100nF,10%,16V,X7R,TP,1608

2203-005005	C393	C-CERAMIC,CHIP	100nF,10%,16V,X7R,TP,1608
2203-005005	C397	C-CERAMIC,CHIP	100nF,10%,16V,X7R,TP,1608
2203-005005	C398	C-CERAMIC,CHIP	100nF,10%,16V,X7R,TP,1608
2203-005005	C399	C-CERAMIC,CHIP	100nF,10%,16V,X7R,TP,1608
2203-005005	C406	C-CERAMIC,CHIP	100nF,10%,16V,X7R,TP,1608
2203-005005	C485	C-CERAMIC,CHIP	100nF,10%,16V,X7R,TP,1608
2203-005005	C486	C-CERAMIC,CHIP	100nF,10%,16V,X7R,TP,1608
2203-005005	C492	C-CERAMIC,CHIP	100nF,10%,16V,X7R,TP,1608
2203-005005	C549	C-CERAMIC,CHIP	100nF,10%,16V,X7R,TP,1608
2203-005005	C551	C-CERAMIC,CHIP	100nF,10%,16V,X7R,TP,1608
2203-005005	C589	C-CERAMIC,CHIP	100nF,10%,16V,X7R,TP,1608
2203-005005	C601	C-CERAMIC,CHIP	100nF,10%,16V,X7R,TP,1608
2203-005005	C602	C-CERAMIC,CHIP	100nF,10%,16V,X7R,TP,1608
2203-005005	C605	C-CERAMIC,CHIP	100nF,10%,16V,X7R,TP,1608
2203-005005	C606	C-CERAMIC,CHIP	100nF,10%,16V,X7R,TP,1608
2203-005005	C607	C-CERAMIC,CHIP	100nF,10%,16V,X7R,TP,1608
2203-005005	C609	C-CERAMIC,CHIP	100nF,10%,16V,X7R,TP,1608
2203-005005	C613	C-CERAMIC,CHIP	100nF,10%,16V,X7R,TP,1608
2203-005005	C619	C-CERAMIC,CHIP	100nF,10%,16V,X7R,TP,1608
2203-005005	C625	C-CERAMIC,CHIP	100nF,10%,16V,X7R,TP,1608
2203-005005	C626	C-CERAMIC,CHIP	100nF,10%,16V,X7R,TP,1608
2203-005005	C824	C-CERAMIC,CHIP	100nF,10%,16V,X7R,TP,1608
2203-005005	C873	C-CERAMIC,CHIP	100nF,10%,16V,X7R,TP,1608
2203-005005	C874	C-CERAMIC,CHIP	100nF,10%,16V,X7R,TP,1608
2203-005005	C875	C-CERAMIC,CHIP	100nF,10%,16V,X7R,TP,1608
2203-005005	C884	C-CERAMIC,CHIP	100nF,10%,16V,X7R,TP,1608
2203-005005	C886	C-CERAMIC,CHIP	100nF,10%,16V,X7R,TP,1608
2203-005005	C912	C-CERAMIC,CHIP	100nF,10%,16V,X7R,TP,1608
2203-005005	C917	C-CERAMIC,CHIP	100nF,10%,16V,X7R,TP,1608
2203-005005	C9562	C-CERAMIC,CHIP	100nF,10%,16V,X7R,TP,1608
2203-005005	C9563	C-CERAMIC,CHIP	100nF,10%,16V,X7R,TP,1608
2203-005005	C9585	C-CERAMIC,CHIP	100nF,10%,16V,X7R,TP,1608
2203-005005	C9587	C-CERAMIC,CHIP	100nF,10%,16V,X7R,TP,1608
2203-005005	C9588	C-CERAMIC,CHIP	100nF,10%,16V,X7R,TP,1608
2203-005005	C9589	C-CERAMIC,CHIP	100nF,10%,16V,X7R,TP,1608
2203-005005	C9590	C-CERAMIC,CHIP	100nF,10%,16V,X7R,TP,1608
2203-005005	C9591	C-CERAMIC,CHIP	100nF,10%,16V,X7R,TP,1608
2203-005005	C9592	C-CERAMIC,CHIP	100nF,10%,16V,X7R,TP,1608
2203-005005	U118	C-CERAMIC,CHIP	100nF,10%,16V,X7R,TP,1608
2203-005005	U124	C-CERAMIC,CHIP	100nF,10%,16V,X7R,TP,1608
2203-005005	U125	C-CERAMIC,CHIP	100nF,10%,16V,X7R,TP,1608
2203-005005	U126	C-CERAMIC,CHIP	100nF,10%,16V,X7R,TP,1608
2203-005065	C261	C-CERAMIC,CHIP	1000nF,+80-20%,10V,Y5V,TP,1608
2203-005065	C264	C-CERAMIC,CHIP	1000nF,+80-20%,10V,Y5V,TP,1608
2203-005065	C988	C-CERAMIC,CHIP	1000nF,+80-20%,10V,Y5V,TP,1608
2203-005065	C989	C-CERAMIC,CHIP	1000nF,+80-20%,10V,Y5V,TP,1608
2203-006017	C221	C-CERAMIC,CHIP	0.56NF,5%,50V,COG,TP,1608
2203-006017	C224	C-CERAMIC,CHIP	0.56NF,5%,50V,COG,TP,1608
2402-000108	C3405	C-AL,SMD	10uF,20%,16V,WT,TP,4.3x4.3x5.4
2402-000108	C3406	C-AL,SMD	10uF,20%,16V,WT,TP,4.3x4.3x5.4
2402-000108	C3407	C-AL,SMD	10uF,20%,16V,WT,TP,4.3x4.3x5.4
2402-000108	C488	C-AL,SMD	10uF,20%,16V,WT,TP,4.3x4.3x5.4
2402-000108	C489	C-AL,SMD	10uF,20%,16V,WT,TP,4.3x4.3x5.4
2402-000108	C491	C-AL,SMD	10uF,20%,16V,WT,TP,4.3x4.3x5.4
2402-000108	C552	C-AL,SMD	10uF,20%,16V,WT,TP,4.3x4.3x5.4
2402-000108	C561	C-AL,SMD	10uF,20%,16V,WT,TP,4.3x4.3x5.4
2402-000108	C622	C-AL,SMD	10uF,20%,16V,WT,TP,4.3x4.3x5.4
2402-000135	C218	C-AL,SMD	22uF,20%,16V,GP,TP,5.3x5.3x5.4
2402-000135	C223	C-AL,SMD	22uF,20%,16V,GP,TP,5.3x5.3x5.4

2402-000135	C236	C-AL, SMD	22uF, 20%, 16V, GP, TP, 5.3x5.3x5.4
2402-000135	C250	C-AL, SMD	22uF, 20%, 16V, GP, TP, 5.3x5.3x5.4
2402-000135	C251	C-AL, SMD	22uF, 20%, 16V, GP, TP, 5.3x5.3x5.4
2402-000135	C252	C-AL, SMD	22uF, 20%, 16V, GP, TP, 5.3x5.3x5.4
2402-000135	C254	C-AL, SMD	22uF, 20%, 16V, GP, TP, 5.3x5.3x5.4
2402-000135	C258	C-AL, SMD	22uF, 20%, 16V, GP, TP, 5.3x5.3x5.4
2402-000135	C269	C-AL, SMD	22uF, 20%, 16V, GP, TP, 5.3x5.3x5.4
2402-000135	C339	C-AL, SMD	22uF, 20%, 16V, GP, TP, 5.3x5.3x5.4
2402-000135	C345	C-AL, SMD	22uF, 20%, 16V, GP, TP, 5.3x5.3x5.4
2402-000135	C411	C-AL, SMD	22uF, 20%, 16V, GP, TP, 5.3x5.3x5.4
2402-000135	C575	C-AL, SMD	22uF, 20%, 16V, GP, TP, 5.3x5.3x5.4
2402-000135	C828	C-AL, SMD	22uF, 20%, 16V, GP, TP, 5.3x5.3x5.4
2402-000135	C904	C-AL, SMD	22uF, 20%, 16V, GP, TP, 5.3x5.3x5.4
2402-000135	C906	C-AL, SMD	22uF, 20%, 16V, GP, TP, 5.3x5.3x5.4
2402-000135	C907	C-AL, SMD	22uF, 20%, 16V, GP, TP, 5.3x5.3x5.4
2402-000135	C9556	C-AL, SMD	22uF, 20%, 16V, GP, TP, 5.3x5.3x5.4
2402-000135	C9557	C-AL, SMD	22uF, 20%, 16V, GP, TP, 5.3x5.3x5.4
2402-000135	C9558	C-AL, SMD	22uF, 20%, 16V, GP, TP, 5.3x5.3x5.4
2402-000135	U120	C-AL, SMD	22uF, 20%, 16V, GP, TP, 5.3x5.3x5.4
2402-000135	U121	C-AL, SMD	22uF, 20%, 16V, GP, TP, 5.3x5.3x5.4
2402-000170	C3404	C-AL, SMD	1uF, 20%, 50V, GP, TP, 4.3x4.3x5.4
2402-000170	C343	C-AL, SMD	1uF, 20%, 50V, GP, TP, 4.3x4.3x5.4
2402-000170	C346	C-AL, SMD	1uF, 20%, 50V, GP, TP, 4.3x4.3x5.4
2402-000170	C350	C-AL, SMD	1uF, 20%, 50V, GP, TP, 4.3x4.3x5.4
2402-000170	C351	C-AL, SMD	1uF, 20%, 50V, GP, TP, 4.3x4.3x5.4
2402-000170	C358	C-AL, SMD	1uF, 20%, 50V, GP, TP, 4.3x4.3x5.4
2402-000170	C503	C-AL, SMD	1uF, 20%, 50V, GP, TP, 4.3x4.3x5.4
2402-000170	C612	C-AL, SMD	1uF, 20%, 50V, GP, TP, 4.3x4.3x5.4
2402-000170	C870	C-AL, SMD	1uF, 20%, 50V, GP, TP, 4.3x4.3x5.4
2402-000170	U116	C-AL, SMD	1uF, 20%, 50V, GP, TP, 4.3x4.3x5.4
2402-000173	C553	C-AL, SMD	4.7uF, 20%, 35V, GP, TP, 4.3x4.3x5.
2402-000173	C554	C-AL, SMD	4.7uF, 20%, 35V, GP, TP, 4.3x4.3x5.
2402-000173	C555	C-AL, SMD	4.7uF, 20%, 35V, GP, TP, 4.3x4.3x5.
2402-000173	C556	C-AL, SMD	4.7uF, 20%, 35V, GP, TP, 4.3x4.3x5.
2402-000173	C557	C-AL, SMD	4.7uF, 20%, 35V, GP, TP, 4.3x4.3x5.
2402-000173	C563	C-AL, SMD	4.7uF, 20%, 35V, GP, TP, 4.3x4.3x5.
2402-000173	C564	C-AL, SMD	4.7uF, 20%, 35V, GP, TP, 4.3x4.3x5.
2402-000176	C502	C-AL, SMD	10uF, 20%, 16V, GP, TP, 4.3x4.3x5.4
2402-000176	C545	C-AL, SMD	10uF, 20%, 16V, GP, TP, 4.3x4.3x5.4
2402-000176	C546	C-AL, SMD	10uF, 20%, 16V, GP, TP, 4.3x4.3x5.4
2402-000176	C566	C-AL, SMD	10uF, 20%, 16V, GP, TP, 4.3x4.3x5.4
2402-000179	C311	C-AL, SMD	47uF, 20%, 16V, GP, TP, 6.6x6.6x5.4
2402-000179	C497	C-AL, SMD	47uF, 20%, 16V, GP, TP, 6.6x6.6x5.4
2402-000179	C577	C-AL, SMD	47uF, 20%, 16V, GP, TP, 6.6x6.6x5.4
2402-000179	C603	C-AL, SMD	47uF, 20%, 16V, GP, TP, 6.6x6.6x5.4
2402-000179	C611	C-AL, SMD	47uF, 20%, 16V, GP, TP, 6.6x6.6x5.4
2402-000179	C9559	C-AL, SMD	47uF, 20%, 16V, GP, TP, 6.6x6.6x5.4
2402-000209	C231	C-AL, SMD	22uF, 20%, 16V, WT, TP, 5.3x5.3mm, 1
2402-000209	C241	C-AL, SMD	22uF, 20%, 16V, WT, TP, 5.3x5.3mm, 1
2402-000209	C284	C-AL, SMD	22uF, 20%, 16V, WT, TP, 5.3x5.3mm, 1
2402-000209	C285	C-AL, SMD	22uF, 20%, 16V, WT, TP, 5.3x5.3mm, 1
2402-000209	C903	C-AL, SMD	22uF, 20%, 16V, WT, TP, 5.3x5.3mm, 1
2402-000209	C916	C-AL, SMD	22uF, 20%, 16V, WT, TP, 5.3x5.3mm, 1
2402-000209	C9560	C-AL, SMD	22uF, 20%, 16V, WT, TP, 5.3x5.3mm, 1
2402-001018	C504	C-AL, SMD	470nF, 20%, 50V, GP, TP, 4.3x4.3x5.
2402-001018	C505	C-AL, SMD	470nF, 20%, 50V, GP, TP, 4.3x4.3x5.
2402-001019	C616	C-AL, SMD	2.2uF, 20%, 35V, GP, TP, 3.3x3.3x5.4
2402-001042	C041	C-AL, SMD	100uF, 20%, 16V, GP, TP, 6.6x6.6x5.4mm
2402-001042	C247	C-AL, SMD	100uF, 20%, 16V, GP, TP, 6.6x6.6x5.4mm

2402-001042	C281	C-AL, SMD	100uF, 20%, 16V, GP, TP, 6. 6x6. 6x5. 4mm
2402-001042	C336	C-AL, SMD	100uF, 20%, 16V, GP, TP, 6. 6x6. 6x5. 4mm
2402-001042	C382	C-AL, SMD	100uF, 20%, 16V, GP, TP, 6. 6x6. 6x5. 4mm
2402-001042	C392	C-AL, SMD	100uF, 20%, 16V, GP, TP, 6. 6x6. 6x5. 4mm
2402-001042	C405	C-AL, SMD	100uF, 20%, 16V, GP, TP, 6. 6x6. 6x5. 4mm
2402-001042	C535	C-AL, SMD	100uF, 20%, 16V, GP, TP, 6. 6x6. 6x5. 4mm
2402-001042	C604	C-AL, SMD	100uF, 20%, 16V, GP, TP, 6. 6x6. 6x5. 4mm
2402-001042	C621	C-AL, SMD	100uF, 20%, 16V, GP, TP, 6. 6x6. 6x5. 4mm
2402-001042	C809	C-AL, SMD	100uF, 20%, 16V, GP, TP, 6. 6x6. 6x5. 4mm
2402-001042	C847	C-AL, SMD	100uF, 20%, 16V, GP, TP, 6. 6x6. 6x5. 4mm
2402-001042	C861	C-AL, SMD	100uF, 20%, 16V, GP, TP, 6. 6x6. 6x5. 4mm
2402-001042	C891	C-AL, SMD	100uF, 20%, 16V, GP, TP, 6. 6x6. 6x5. 4mm
2402-001042	C892	C-AL, SMD	100uF, 20%, 16V, GP, TP, 6. 6x6. 6x5. 4mm
2402-001042	C895	C-AL, SMD	100uF, 20%, 16V, GP, TP, 6. 6x6. 6x5. 4mm
2402-001042	U127	C-AL, SMD	100uF, 20%, 16V, GP, TP, 6. 6x6. 6x5. 4mm
2402-001086	C9567	C-AL, SMD	100UF, 20%, 16V, WT, TP, 6. 6X6. 6X5. 3
2402-001086	U128	C-AL, SMD	100UF, 20%, 16V, WT, TP, 6. 6X6. 6X5. 3
2402-001128	C845	C-AL, SMD	100UF, 20%, 16V, WT, TP, 6. 3X5. 7MM
2402-001128	C851	C-AL, SMD	100UF, 20%, 16V, WT, TP, 6. 3X5. 7MM
2402-001128	C857	C-AL, SMD	100UF, 20%, 16V, WT, TP, 6. 3X5. 7MM
2402-001128	C898	C-AL, SMD	100UF, 20%, 16V, WT, TP, 6. 3X5. 7MM
2402-001155	C200	C-AL, SMD	47UF, 20%, 16V, WT, TP, 6. 3X5. 2MM
2402-001155	C288	C-AL, SMD	47UF, 20%, 16V, WT, TP, 6. 3X5. 2MM
2402-001155	C289	C-AL, SMD	47UF, 20%, 16V, WT, TP, 6. 3X5. 2MM
2402-001155	C329	C-AL, SMD	47UF, 20%, 16V, WT, TP, 6. 3X5. 2MM
2409-001046	C816	C-ORGANIC	39UF, 20%, 16V, WT, TP, 6. 3X6 MM, -
2409-001049	C810	C-ORGANIC	47UF, 20%, 6. 3V, FX, TP, 5X5. 9MM, -
2409-001049	C813	C-ORGANIC	47UF, 20%, 6. 3V, FX, TP, 5X5. 9MM, -
2409-001049	C815	C-ORGANIC	47UF, 20%, 6. 3V, FX, TP, 5X5. 9MM, -
2409-001049	C818	C-ORGANIC	47UF, 20%, 6. 3V, FX, TP, 5X5. 9MM, -
2409-001049	C827	C-ORGANIC	47UF, 20%, 6. 3V, FX, TP, 5X5. 9MM, -
2409-001049	C865	C-ORGANIC	47UF, 20%, 6. 3V, FX, TP, 5X5. 9MM, -
2409-001049	C867	C-ORGANIC	47UF, 20%, 6. 3V, FX, TP, 5X5. 9MM, -
2409-001049	C869	C-ORGANIC	47UF, 20%, 6. 3V, FX, TP, 5X5. 9MM, -
2409-001049	C876	C-ORGANIC	47UF, 20%, 6. 3V, FX, TP, 5X5. 9MM, -
2409-001049	C890	C-ORGANIC	47UF, 20%, 6. 3V, FX, TP, 5X5. 9MM, -
2409-001049	U129	C-ORGANIC	47UF, 20%, 6. 3V, FX, TP, 5X5. 9MM, -
2503-001018	CA300	C-NETWORK	15PFX4, 10%, 50V, -
2503-001018	CA301	C-NETWORK	15PFX4, 10%, 50V, -
2503-001018	CA302	C-NETWORK	15PFX4, 10%, 50V, -
2503-001018	CA303	C-NETWORK	15PFX4, 10%, 50V, -
2503-001018	CA304	C-NETWORK	15PFX4, 10%, 50V, -
2503-001018	CA305	C-NETWORK	15PFX4, 10%, 50V, -
2703-000398	L008	INDUCTOR-SMD	10uH, 10%, 3. 2x2. 5x2. 2mm
2703-001778	L201	INDUCTOR-SMD	3. 3UH, 20%, 3. 2X2. 5X2. 2MM
2703-001778	L202	INDUCTOR-SMD	3. 3UH, 20%, 3. 2X2. 5X2. 2MM
2703-001778	L203	INDUCTOR-SMD	3. 3UH, 20%, 3. 2X2. 5X2. 2MM
2703-001778	L204	INDUCTOR-SMD	3. 3UH, 20%, 3. 2X2. 5X2. 2MM
2703-001778	L205	INDUCTOR-SMD	3. 3UH, 20%, 3. 2X2. 5X2. 2MM
2703-001778	L206	INDUCTOR-SMD	3. 3UH, 20%, 3. 2X2. 5X2. 2MM
2703-001778	L207	INDUCTOR-SMD	3. 3UH, 20%, 3. 2X2. 5X2. 2MM
2703-001778	L208	INDUCTOR-SMD	3. 3UH, 20%, 3. 2X2. 5X2. 2MM
2703-001778	L301	INDUCTOR-SMD	3. 3UH, 20%, 3. 2X2. 5X2. 2MM
2703-001778	L555	INDUCTOR-SMD	3. 3UH, 20%, 3. 2X2. 5X2. 2MM
2703-002327	L540	INDUCTOR-SMD	3. 9UH, 55, 3. 2X2. 5X2. 2MM
2703-002327	L541	INDUCTOR-SMD	3. 9UH, 55, 3. 2X2. 5X2. 2MM
2704-000001	FT925	INDUCTOR-SMD-ARRAY	4000HM, 50V, 0. 5A, -, -, 0. 30HM, -25T085C
2704-000001	FT926	INDUCTOR-SMD-ARRAY	4000HM, 50V, 0. 5A, -, -, 0. 30HM, -25T085C
2704-000001	FT933	INDUCTOR-SMD-ARRAY	4000HM, 50V, 0. 5A, -, -, 0. 30HM, -25T085C

2704-000001	FT934	INDUCTOR-SMD-ARRAY	4000HM,50V,0.5A,-,0.30HM,-25T085C	
2704-000004	FT935	INDUCTOR-SMD-ARRAY	2000HM,50V,0.5A,-,0.20HM,-25CT0+85C	
2801-003667	X201	CRYSTAL-SMD	14.3182MHZ,50PPM,28-AAN,16,500HM,TP	
2801-003843	X511	CRYSTAL-SMD	18.432MHz,30ppm,28-AAN,20pF,50ohm,TP	
2801-004117	X601	CRYSTAL-SMD	6MHZ,30PPM,28-ABX,20PF,1500HM,TP	
2901-001114	F187	FILTER-EMI SMD	25VDC,2.0ADC,-,100nF,3.2x1.6x1	
2901-001114	FT214	FILTER-EMI SMD	25VDC,2.0ADC,-,100nF,3.2x1.6x1	
2901-001114	FT281	FILTER-EMI SMD	25VDC,2.0ADC,-,100nF,3.2x1.6x1	
2901-001114	FT401	FILTER-EMI SMD	25VDC,2.0ADC,-,100nF,3.2x1.6x1	
2901-001114	FT901	FILTER-EMI SMD	25VDC,2.0ADC,-,100nF,3.2x1.6x1	
2901-001114	FT902	FILTER-EMI SMD	25VDC,2.0ADC,-,100nF,3.2x1.6x1	
2901-001114	FT903	FILTER-EMI SMD	25VDC,2.0ADC,-,100nF,3.2x1.6x1	
2901-001114	FT904	FILTER-EMI SMD	25VDC,2.0ADC,-,100nF,3.2x1.6x1	
2901-001114	FT923	FILTER-EMI SMD	25VDC,2.0ADC,-,100nF,3.2x1.6x1	
2901-001114	FT924	FILTER-EMI SMD	25VDC,2.0ADC,-,100nF,3.2x1.6x1	
3301-001145	FT201	CORE-FERRITE BEAD	AB,4.5x1.6x1.6mm,-,-	SNA
3301-001145	FT206	CORE-FERRITE BEAD	AB,4.5x1.6x1.6mm,-,-	SNA
3301-001145	FT210	CORE-FERRITE BEAD	AB,4.5x1.6x1.6mm,-,-	SNA
3301-001145	FT211	CORE-FERRITE BEAD	AB,4.5x1.6x1.6mm,-,-	SNA
3301-001145	FT304	CORE-FERRITE BEAD	AB,4.5x1.6x1.6mm,-,-	SNA
3301-001145	FT812	CORE-FERRITE BEAD	AB,4.5x1.6x1.6mm,-,-	SNA
3301-001145	FT813	CORE-FERRITE BEAD	AB,4.5x1.6x1.6mm,-,-	SNA
3301-001145	FT814	CORE-FERRITE BEAD	AB,4.5x1.6x1.6mm,-,-	SNA
3301-001145	FT815	CORE-FERRITE BEAD	AB,4.5x1.6x1.6mm,-,-	SNA
3301-001145	FT816	CORE-FERRITE BEAD	AB,4.5x1.6x1.6mm,-,-	SNA
3301-001145	FT817	CORE-FERRITE BEAD	AB,4.5x1.6x1.6mm,-,-	SNA
3301-001145	FT818	CORE-FERRITE BEAD	AB,4.5x1.6x1.6mm,-,-	SNA
3301-001145	FT821	CORE-FERRITE BEAD	AB,4.5x1.6x1.6mm,-,-	SNA
3301-001145	FT822	CORE-FERRITE BEAD	AB,4.5x1.6x1.6mm,-,-	SNA
3301-001145	FT824	CORE-FERRITE BEAD	AB,4.5x1.6x1.6mm,-,-	SNA
3301-001145	FT825	CORE-FERRITE BEAD	AB,4.5x1.6x1.6mm,-,-	SNA
3301-001145	FT851	CORE-FERRITE BEAD	AB,4.5x1.6x1.6mm,-,-	SNA
3301-001145	FT852	CORE-FERRITE BEAD	AB,4.5x1.6x1.6mm,-,-	SNA
3301-001145	FT877	CORE-FERRITE BEAD	AB,4.5x1.6x1.6mm,-,-	SNA
3301-001145	FT878	CORE-FERRITE BEAD	AB,4.5x1.6x1.6mm,-,-	SNA
3301-001145	FT927	CORE-FERRITE BEAD	AB,4.5x1.6x1.6mm,-,-	SNA
3301-001145	U130	CORE-FERRITE BEAD	AB,4.5x1.6x1.6mm,-,-	SNA
3301-001605	FT928	CORE-FERRITE BEAD	AB,3600HM,2.0X1.2X1.2MM,100MA,TP,FERRITE,0.50HM	SNA
3301-001605	FT929	CORE-FERRITE BEAD	AB,3600HM,2.0X1.2X1.2MM,100MA,TP,FERRITE,0.50HM	SNA
3301-001605	FT930	CORE-FERRITE BEAD	AB,3600HM,2.0X1.2X1.2MM,100MA,TP,FERRITE,0.50HM	SNA
3301-001605	FT931	CORE-FERRITE BEAD	AB,3600HM,2.0X1.2X1.2MM,100MA,TP,FERRITE,0.50HM	SNA
3301-001605	FT932	CORE-FERRITE BEAD	AB,3600HM,2.0X1.2X1.2MM,100MA,TP,FERRITE,0.50HM	SNA
3704-000249	IC620_SOCKET	SOCKET-IC	32P,PLCC,SN,1.27mm	
3711-000556	CN701	CONNECTOR-HEADER	BOX,12P,1R,1.25mm,SMD-A,SN	SNA
3711-000922	CN501	CONNECTOR-HEADER	BOX,4P,1R,1.25mm,SMD-A,SN	
3711-002046	CN512	CONNECTOR-HEADER	3WALL,12P,1R,1.25mm,SMD-S,SN	SNA
3711-002049	CN511	CONNECTOR-HEADER	BOX,6P,1R,1.25mm,SMD-A,SN	SNA
3711-002127	CN754	CONNECTOR-HEADER	BOX,8P,1R,1.25mm,SMD-A,SN	SNA
3711-003161	CN901	CONNECTOR-HEADER	BOX,20P,1R,1.25mm,ANGLE,SN	
3711-004130	CN575	CONNECTOR-HEADER	BOX,31P,2R,0.625mm,SMD-A,AUF	
3711-004933	CN502	CONNECTOR-HEADER	BOX,3P,1R,1.25MM,SMD-A,SN,WHT	SNA
3711-004933	CN706_1	CONNECTOR-HEADER	BOX,3P,1R,1.25MM,SMD-A,SN,WHT	SNA
3711-005154	CN505	CONNECTOR-HEADER	BOX,21P,2R,1.25MM,SMD-A,AUF,BLK	SNA
BN27-00009A	L806	COIL CHOKE	SMD 12X12X6,EOS,33UH,15%,-,0.12 MAX,2A,DR10X5.0MM,18.5TS,12X12X6,1.8MM,1UEW 0.	
BN27-00010A	L801	COIL CHOKE	-,NK17NS,100UH,10%,-,0.7 MAX,6A,DR5.8X4.5MM,59.5TS,6.0X5.2X4.5MM,1.8MM,1UEW 0.	
BN27-00010A	L804	COIL CHOKE	-,NK17NS,100UH,10%,-,0.7 MAX,6A,DR5.8X4.5MM,59.5TS,6.0X5.2X4.5MM,1.8MM,1UEW 0.	
BN27-20001A	L807	COIL-CHOKE	-,53.0UH,20%,DR10*5,-,-,-,0.18ohm,-,-,-,TRAY	
BN27-20001A	L818	COIL-CHOKE	-,53.0UH,20%,DR10*5,-,-,-,0.18ohm,-,-,-,TRAY	
BN41-00169A	MP1.0	PCB MAIN	MB15NOA,FR4,6L,175X181X1.23,MB15NOA	SNA

BN91-00445A	-	ASSY SHIELD	MB15UO	SNA
6003-000117	SH/PCB+C/F	SCREW-TAPTITE	BH,+ ,B,M3,L6,ZPC(YEL),SWRCH18A	SNA
6003-000117	SH/PCB+IN/PCB	SCREW-TAPTITE	BH,+ ,B,M3,L6,ZPC(YEL),SWRCH18A	SNA
6003-000117	SH/PCB+M/PCB	SCREW-TAPTITE	BH,+ ,B,M3,L6,ZPC(YEL),SWRCH18A	SNA
BN02-00010A	CIS	TAPE ETC	MINERVA,AL-TAPE,0.07MM,60MM,80MM,SILVER,DK-100-60-80	SNA
BN59-00289A	CIS	BOARD-INPUT ASS'Y	MB15UO,INPUT ASS'Y	SNA
BN63-00440A	CIS	FELT-SPACER	MB15KO,FELT,TO.35,10,71.5,BLK	SNA
BN63-00440B	CIS	FELT-SPACER	MB15KO,FELT,TO.35,10,187,BLK	SNA
BN63-00495A	CIS	GASKET	MINERVA,CONDUCTIVE FABLIC,0.13MM,80MM,80MM,GRAY,DK-K102-80-80,CONDUCTIVE TAPE	SNA
BN90-00256A	CIS	ASSY SHIELD-PCB	RB15,-,SECC TO.5,-,-,-,-,-	SNA
BN63-00177A	CIS	SHIELD-PCB	RB15,SECC,TO.5,-,-,-,-,-	SNA
BN71-00022A	CIS	EARTH PLATE	RB15AS,SUS,TO.15	SNA
BN91-00567K	-	ASSY LCD	ES15/MB15,S3	SNA
BN07-00111A	CIS	LCD	LTM150XH-L06,CZB,6BIT_ FRC,331.6*254.76*12.5,16.19M,-,0.297*0.297,-,-,AMLCD/1 LV	
BN92-00436A	-	ASSY BOX	MB15NO	SNA
BH68-00329A	CIS	LABEL BAR CODE	ALL,MPRII,DOM,EXPORT,ART-PAPER 90G,-,-,-,-,-,WHT,-,-,-	SNA
BH75-10529A	CIS	UNIT-HANDLE PACKING	LXA410TLMU,PE,-,WHITE,-	SNA
BN72-60001A	CIS	LEVER TOP	LSD210TL,PE-LD,WHITE,TFT_LCD	SNA
BN72-60002A	CIS	LEVER BOTTOM	LSD210TL,PE-LD,WHITE,TFT-LCD	SNA
BN69-00341B	CIS	BOX	LYM1525,ADC,CB-SW4,YEL,A-1,L523*W415*H90	SNA
BN92-00437A	-	ASSY LABEL	MB15NO	SNA
BN68-00267A	CIS	LABEL RATING	MB15UO,ADC,PE,TO.05,65,79,PE NATURE	SNA
BN92-00439A	-	ASSY P/MATERIAL	MB15NO	SNA
0203-001100	CIS	TAPE-OPP MASKING	OPP/W75/CLR,TO.05,W75,L800000,CLR	SNA
BH69-00256C	CIS	PAD-PACKING-EDGE	MV940,B400,W200,L2030,-,-,YEL,-,-,-	SNA
BH69-00260A	CIS	BAG AIR	DP17L,PE,0.2,1800,1000,NATURAL,-	SNA
BH69-30002C	CIS	BAG-PE	LDPE,TO.05,W2400,NO_PRINT	SNA
BH69-30348C	CIS	BAG-PE	HDPE,TO.02,W350*L430,Y,-,CGB51	SNA
BH69-30355E	CIS	BAG-PE/N	NK15,PE FOAM,0.5,650,650,NTR	SNA
BH69-30360A	CIS	BAG-AIR	HDPE,TO.2,W1000*L1800,N,-,ALL	SNA
BH69-40380A	CIS	PACKING-PAD	DW-2,500X2200X200,-,CGK5527	SNA
BN69-00274A	CIS	CUSHION	RB15,EPS,-,-,-,-,-,M50	SNA
BN69-00293F	CIS	PALLET-PACKING	MB15,STEEL,1290,1080,100	SNA
BN92-00578Z	-	ASSY ACCESSORY	LTM1525X/XAA,SEA,UNITED STATES	SNA
BN59-00224B	CIS	REMOCON	,TM71,NIKE,42,GR20,NTSC,EX	
BN96-00145Z	CIS	ASSY ACCESSORY	LTM1525X/XAA,SEA,UNITED STATES	
0203-000214	CIS	TAPE-OPP MASKING	OPP/W50/CLR,TO.05,W50,L400000,	SNA
4301-000121	CIS	BATTERY-MN	1.5V,-,AAA,10.5x44.5m,HOLDER	SNA
BH39-10339X	CIS	CBF POWER CORD	DET,SVT,125V/7A,BLK,1830,WALL(ST),MSP-33,MSC-30	
BH39-40355W	CIS	CBF-HARNESS	-,2000MM,IVORY,-,-,-	
BH69-30348D	CIS	BAG-PE	LDPE,TO.05,W240*L356,Y,-,CMG73	SNA
BN39-00043A	CIS	CBF SIGNAL	DETACHABLE,-,15P/15P,-,-,-	
BN96-00159A	CIS	ASSY ACCESSORY	LTM1525X/XAA,SEA,UNITED STATES	
0203-000214	CIS	TAPE-OPP MASKING	OPP/W50/CLR,TO.05,W50,L400000,	SNA
AA68-00371C	CIS	CARD WARRANTY-01	,SEA,W/P100(G),1 YEAR	SNA
BH68-00261P	CIS	MANUAL-00	SEAREGISTRATION CARD,SEA,E,USA,MOJO120G,173,234	SNA
BH69-30348D	CIS	BAG-PE	LDPE,TO.05,W240*L356,Y,-,CMG73	SNA
BN68-00281A	CIS	MANUAL USERS	LTM1525,SAMSUNG,E/F/S/P,ADC,MOJO100G	
S7-LTM1525X/XAA	-	2	LTM150XH-L06 ZPD	-
BN90-00297A	-	ASSY COVER REAR	MB15UO	SNA
6003-001246	C/F+C/R	SCREW-TAPTITE	FH,+ ,B,M3,L10,NI PLT,SWRCH18A	SNA
BN96-00038B	CIS	ASSY COVER P-REAR	MB15UO,USA,ABS HB,SVM-1207	
BN61-00092A	CIS	BRACKET-PIN	RB15,CU+ZN,TO.23,35MM	SNA
BN63-00173A	CIS	COVER-REAR	RB15,ABS,-,-,-,HB,-,BK08,SILVER SPRAY	SNA
BN63-00199A	CIS	COVER-HANDLE	RB15,ABS,HB,BK08,HB,1.5	SNA
BN90-00318A	-	ASSY STAND	MB15NO	SNA
BN90-00257A	CIS	ASSY STAND	RB15,-,ABD HB,-,-,-,-,- Page 45	
6001-001612	CIS	SCREW-MACHINE	CH,+ ,M2,L3.5,ZPC(BLK),SWRCH18A,FP,-	
6003-001347	CIS	SCREW-TAPTITE	FH,+ ,B,M4,L16,ZPC(YEL),SWRCH18A,-	SNA

BN61-00158A	C1S	BRACKET-STAND	MINERVA,STS 420J2,T2.0	SNA
BN63-00176A	C1S	COVER-STAND	RB15,ABS,-,-,-,HB,-,BK08,HB,1.5	SNA
BN73-60002A	C1S	RUBBER-FOOT	CY15PO,SPONGE,-,-,-,BL,-,-,-,-	SNA
BN90-00258A	C1S	ASSY HINGE	RB15,-,AL,-,-,-,-,DIE-CASTING	SNA
BN90-00341A	-	ASSY COVER FRONT	MB15UO	SNA
BN90-00255C	C1S	ASSY COVER FRONT	MB15UO,USA,ABS V0,SVM-1207	
6003-000259	C1S	SCREW-TAPTITE	BH,+ ,B,M3,L8,ZPC(YEL),SWRCH18A	SNA
BN59-00282A	C1S	SPEAKER SYSTEM	MINERVA,MINERVA-R,3W,46X46X20,3W 40HM, WIRE:395MM	
BN59-00283A	C1S	SPEAKER SYSTEM	MINERVA,MINERVA-L,3W,46X46X20,3W 40HM, WIRE:110MM	
BN59-00287A	C1S	BOARD-FUNCTION ASS'Y	MB15UO,CT5000-0610,FUNCTION ASS'Y	SNA
BN59-00288A	C1S	BOARD-PHONE JACK ASS'Y	MB15UO,CT5000-0620,PHONE-JACK ASS'Y	SNA
BN61-00082A	C1S	BRACKET-SPRING-STAND	RB15,SUS,TO.5,-,-,-,-	SNA
BN63-00172A	C1S	COVER-FRONT	RB15,ABS,-,-,-,HB,-,BK08,SILVER SPRAY	SNA
BN63-00175A	C1S	COVER-LENS	RB15,ABS,-,-,-,HB,-,IV16,NONE,1.5	SNA
BN64-00031A	C1S	BADGE-BRAND	RB15AS,AL,T1.4,6.3,40.1,-,SILVER,-	SNA
BN64-00056A	C1S	KNOB-POWER	RB15,PC,-,-,-,HB,CLEAR,-,NI-CR	
BN64-00057A	C1S	KNOB-FUNCTION	RB15,ABS+PC,-,-,-,HB,BK08,-,NONE,1.5	
BN67-00048A	C1S	LENS-IR	RB15,ACRYL,CLEAR,-,1.5,-,HALF-MIRROR	SNA
BN67-00054A	C1S	LENS-LED	RB15,ACRYL,CLEAR,1	
BN91-00310F	-	ASSY MISC	MB15	SNA
BN44-00063A	C1S	ADAPTOR	AD-4914N,EOS17,100-240VAC,47 - 63 HZ,+14VDC,3.5A,-,49W,-,0 TO +40 C,120*63*31,SA	
BN91-00394A	-	ASSY CHASSIS	MB15NO	
BN94-00309A	-	ASSY PCB MAIN	MB15NO	SNA
0201-001223	C1S	ADHESIVE-TS	HT-130S,RED,700+/- 50,-	SNA
0202-001044	C1S	SOLDER-WIRE.	S63S-W3.0,S63S,D3,63Sn/37Pb,-	SNA
0202-001046	C1S	SOLDER-WIRE FLUX	CF-110VH-2A,-,-,-,-	SNA
0202-001222	C1S	SOLDER-WIRE FLUX	RS-107,RS60-1.2AA,D1.2,SN60/PB40,-	SNA
0204-001095	C1S	THINNER	#4520,-,-,-	SNA
BH73-60304E	C1S	RUBBER-SUPPORT	MO15PS,CR V0,6*6*6.4,BLACK	SNA
BN39-00161B	C1S	LEAD CONNECTOR-ASSY	MB15UO,UL1571#30,UL/CSA,12P,#28,12505HS-12,12505HS-12,BK,40MM,1571#30,SJ02-01-05	
BN39-00272A	C1S	LEAD CONNECTOR-ASSY	MB15UO,UL1571#28,UL/CSA,20P,#28,12507HS-20,12507HS-20,BK,50MM,1571#28,SJ01-01-40	
BN39-00275A	C1S	LEAD CONNECTOR-ASSY	MB15UO,UL1061#28,UL/CSA,8P,#28,12505HS-08,12505HS-08,BK,125MM,1061#28,SJ02-01-06	
BN39-00287A	C1S	LEAD CONNECTOR-ASSY	MB15UO,UL1571#28,UL/CSA,21P,#28,FI-W21S,FI-W21S,BK,40MM,1571#28,SJ01-01-405(1)	
BN39-00288A	C1S	LEAD CONNECTOR-ASSY	MB15UO,UL1571#28,UL/CSA,31(25)P,#28,FI-W31S,FI-W31S,BK,40MM,1571#28,SJ01-01-405(1)	
BN44-00061B	C1S	INVERTER	MB15UO,S1C540A,48KHZ,14VDC,3.6MARMS,6.8MARMS,48KHZ,140*65.5*7.0,4LAMP,48KHZ	
BN60-00011A	C1S	FASTENER-PEM/NUT	MINERVA,SUM24L(SN),M3,-,7.0,6.8,WHT	SNA
BN63-00174A	C1S	COVER-PCB	RB15,ABS,-,-,-,V0,-,IV16,TBBA,1.5	SNA
BN63-00345A	C1S	SHIELD-SUB	MO15,SUS,TO.15	SNA
BN63-00413A	C1S	GASKET	MB15KO,CONDUCTIVE FABRIC,5MM,8MM,8MM,GRAY,71TSMK 8-5-8-13-D,71TSMK 8-5-8-13-D	SNA
BN97-00096M	-	ASSY MICOM	MB15NO	
1102-001129	IC620	IC-EPROM	M27W401,512KX8BIT,PLCC,32P,11.35X13.89MM,80NS,3.3V,10%,PLASTIC,-40TO+85C,-,CMOS,	
BN46-00012J	C1S	S/W MICOM	MB15NO	SNA
BN97-00100A	-	ASSY SMD	MB15NO	SNA
0202-001162	C1S	SOLDER-CREAM	RMA-20-21L,S63,-,SN63/PB36.6/AGO.4,FLUX9.5%	SNA
0401-001056	D409	DIODE-SWITCHING	MMBD4148SE,75V,200MA,SOT-23,TP	
0401-001056	D410	DIODE-SWITCHING	MMBD4148SE,75V,200MA,SOT-23,TP	
0401-001056	D411	DIODE-SWITCHING	MMBD4148SE,75V,200MA,SOT-23,TP	
0401-001056	D681	DIODE-SWITCHING	MMBD4148SE,75V,200MA,SOT-23,TP	
0401-001056	D804	DIODE-SWITCHING	MMBD4148SE,75V,200MA,SOT-23,TP	
0402-000553	D802	DIODE-RECTIFIER	SS24,40V,2.0A,DO-214AA	
0402-000553	D875	DIODE-RECTIFIER	SS24,40V,2.0A,DO-214AA	
0402-001098	D803	DIODE-RECTIFIER	SK34,40V,3A,SMC,TP	
0403-000579	D601	DIODE-ZENER	BZX84C5V1,5.1V,5%,200mW,SOT-23	
0403-000579	D602	DIODE-ZENER	BZX84C5V1,5.1V,5%,200mW,SOT-23	
0403-000579	D604	DIODE-ZENER	BZX84C5V1,5.1V,5%,200mW,SOT-23	
0403-001052	D543	DIODE-ZENER	RD8.2MB,8.2V,7.7-8.64V,200mW,S	
0403-001052	D545	DIODE-ZENER	RD8.2MB,8.2V,7.7-8.64V,200mW,S	
0403-001052	D876	DIODE-ZENER	RD8.2MB,8.2V,7.7-8.64V,200mW,S	
0403-001052	D877	DIODE-ZENER	RD8.2MB,8.2V,7.7-8.64V,200mW,S	

0404-001166	D805	DIODE-SCHOTTKY	MBRM130LT3, 30V, 1000MA, DO-216AA, TP
0404-001166	D806	DIODE-SCHOTTKY	MBRM130LT3, 30V, 1000MA, DO-216AA, TP
0501-000342	Q01	TR-SMALL SIGNAL	KSC1623-Y, NPN, 200mW, SOT-23, TP, 135-270
0501-000342	Q611	TR-SMALL SIGNAL	KSC1623-Y, NPN, 200mW, SOT-23, TP, 135-270
0501-002080	Q601	TR-SMALL SIGNAL	2SC2412K, NPN, 200mW, SC-59, TP, 120-270
0501-002080	Q610	TR-SMALL SIGNAL	2SC2412K, NPN, 200mW, SC-59, TP, 120-270
0501-002080	Q808	TR-SMALL SIGNAL	2SC2412K, NPN, 200mW, SC-59, TP, 120-270
0501-002080	Q809	TR-SMALL SIGNAL	2SC2412K, NPN, 200mW, SC-59, TP, 120-270
0501-002080	Q810	TR-SMALL SIGNAL	2SC2412K, NPN, 200mW, SC-59, TP, 120-270
0501-002080	Q811	TR-SMALL SIGNAL	2SC2412K, NPN, 200mW, SC-59, TP, 120-270
0501-002080	Q812	TR-SMALL SIGNAL	2SC2412K, NPN, 200mW, SC-59, TP, 120-270
0505-001170	IC808	FET-SILICON	SI9933ADY-T1, P, -20V, 3.4A, 0.06ohm, 2W, SO-8
0801-002267	IC406	IC-CMOS LOGIC	74LCX14, -, SOIC, 14P, 150MIL, -, TP, -, -, -, 3.6V, -40TO+85C, -, 5.5V, -, -, 24MA
0801-002547	IC408	IC-CMOS LOGIC	74VHC157, MULTIPLEXER, SOP, 16P, 150MIL, QUAD, TP, PLASTIC, -, -, 0.36V, -40to+85C, -, 1.5V, 4
0904-001009	IC631	IC-I/O SUPPORT CHIP	8574A, -, SOP, 16P, 300MIL, 100KHZ,
0904-001009	IC632	IC-I/O SUPPORT CHIP	8574A, -, SOP, 16P, 300MIL, 100KHZ,
1001-001082	IC403	IC-VIDEO SWITCH	BA7657F, -, SOP, 24P, 300MIL, SINGL
1001-001109	IC681	IC-ANALOG SWITCH	FST3125M, BUS SWITCH & CMOS, SOIC, 17P, 150MIL, QUAD, 7V, -40TO+85C, PLASTIC, -, 4.00HM, 5.
1002-001292	IC350	IC-A/D CONVERTER	AD9883AKST-110, 8BITS, QFP, 80P, 551MIL, ±0.5LSB, TR, CMOS, PLASTIC, 3.3V, -25TO+85C, 650M
1003-001419	IC300	IC-DISPLAY DRIVER	MN82860, QFP, 208P, 1102MIL, -, -, TR, PLASTIC, 3.3V, -, 2.3W, -, -
1103-000129	IC401	IC-EEPROM	24C02, 256x8BIT, SOP, 8P, 150MIL, 1
1103-000138	IC603	IC-EEPROM	24C16, 2Kx8BIT, SOP, 8P, 150MIL, 10
1109-001209	IC210	IC-GRAM	M32L32321SA, 2X512KX32BIT, QFP, 100P, -, 7NS, 3.3V, 10%, PLASTIC, -55TO+150C, 2MA, CMOS, TR
1109-001209	IC211	IC-GRAM	M32L32321SA, 2X512KX32BIT, QFP, 100P, -, 7NS, 3.3V, 10%, PLASTIC, -55TO+150C, 2MA, CMOS, TR
1201-001559	IC503	IC-AUDIO AMP	4863, TSSOP, 20P, 173MIL, DUAL, 98dB, PLASTIC, 5.5V, 2.45W, -40to+85C, -, -, -, -
1203-000404	IC811	IC-DC/DC CONVERTER	34063, SOP, 8P, 150MIL, PLASTIC, 1.0/1.3V, -, 0TO+70C, 4.0MA, -, ST
1203-000404	IC812	IC-DC/DC CONVERTER	34063, SOP, 8P, 150MIL, PLASTIC, 1.0/1.3V, -, 0TO+70C, 4.0MA, -, ST
1203-001212	IC604	IC-VOL. DETECTOR	7029, SOT-89, 3P, -, PLASTIC, -, 500
1203-001293	IC301	IC-POSITIONAL REG.	033, TO-252, 3P, 6.5MIL, PLASTIC, 3
1203-001293	IC813	IC-POSITIONAL REG.	033, TO-252, 3P, 6.5MIL, PLASTIC, 3
1203-001448	IC804	IC-SWITCH VOL. REG.	2596, TO-263, 5P, -, PLASTIC, 4.750
1203-001448	IC807	IC-SWITCH VOL. REG.	2596, TO-263, 5P, -, PLASTIC, 4.750
1203-001816	IC803	IC-POSITIONAL REG.	78M08, TO-252, 3P, -, PLASTIC, 7.7/8.3V, 1.0W, -40TO+85C, 0.5A, -, TP
1203-001830	IC805	IC-SWITCH VOL. REG.	2676, TO-263, 7P, -, PLASTIC, 3.234/3.336V, -, -40TO+125C, 3A, -, TP
1203-001890	IC802	IC-VOLTAGE REGULATOR	3961, SOT223-5, 5P, -, PLASTIC, 2.5V, -, -40to+125C, 800mA, -, TR
1203-001890	IC806	IC-VOLTAGE REGULATOR	3961, SOT223-5, 5P, -, PLASTIC, 2.5V, -, -40to+125C, 800mA, -, TR
1204-001551	IC175	IC-VIDEO SYSTEM	GS1881, SOIC, 8P, 150MIL, PLASTIC, 13.2V, -, 0TO+70C, TP, VIDEO SYNC SEPARATOR
1204-001852	IC919	IC-SOUND PROCESSOR	MSP3421G-B8, PQFP, 80P, -, PLASTIC, 9V, 1000MW, 0TO70C, TR, -
1204-001911	IC200	IC-VIDEO PROCESS	DPTV-3D-6730, PQFP, 208P, 28X28MM, PLASTIC, 4.6V, -, 0TO+70C, TR, -
1204-001912	IC601	IC-DECODER	SDA5550M, P-MQFP, 100P, -, PLASTIC, 3.3V, 1.5W, 0TO+70C, TR, -
1205-001740	IC901	IC-TRANSMITTER	DS90C385, TSSOP, 56P, 240MIL, PLASTIC, 4V, 1.63W, -10 TO +70C, ST, FPD LINK-85MHZ (LVDS)
1206-000111	ICA5	IC-TIMER	KA555D/T.R, SOP, 8P, 150MIL, -, 18V
2007-000052	R4564	R-CHIP	10Kohm, 1%, 1/16W, DA, TP, 1608
2007-000052	R4565	R-CHIP	10Kohm, 1%, 1/16W, DA, TP, 1608
2007-000052	R4566	R-CHIP	10Kohm, 1%, 1/16W, DA, TP, 1608
2007-000052	R4567	R-CHIP	10Kohm, 1%, 1/16W, DA, TP, 1608
2007-000052	RA0	R-CHIP	10Kohm, 1%, 1/16W, DA, TP, 1608
2007-000070	R303	R-CHIP	0ohm, 5%, 1/16W, DA, TP, 1608
2007-000070	R328	R-CHIP	0ohm, 5%, 1/16W, DA, TP, 1608
2007-000070	R638	R-CHIP	0ohm, 5%, 1/16W, DA, TP, 1608
2007-000070	R902	R-CHIP	0ohm, 5%, 1/16W, DA, TP, 1608
2007-000071	R355	R-CHIP	22ohm, 5%, 1/16W, DA, TP, 1608
2007-000071	R3590	R-CHIP	22ohm, 5%, 1/16W, DA, TP, 1608
2007-000071	R367	R-CHIP	22ohm, 5%, 1/16W, DA, TP, 1608
2007-000071	R630	R-CHIP	22ohm, 5%, 1/16W, DA, TP, 1608
2007-000072	R329	R-CHIP	47ohm, 5%, 1/16W, DA, TP, 1608
2007-000072	R354	R-CHIP	47ohm, 5%, 1/16W, DA, TP, 1608
2007-000072	R903	R-CHIP	47ohm, 5%, 1/16W, DA, TP, 1608
2007-000072	R904	R-CHIP	47ohm, 5%, 1/16W, DA, TP, 1608

2007-000090	R607	R-CHIP	10KOHM, 5%, 1/16W, DA, TP, 1608
2007-000090	R609	R-CHIP	10KOHM, 5%, 1/16W, DA, TP, 1608
2007-000090	R621	R-CHIP	10KOHM, 5%, 1/16W, DA, TP, 1608
2007-000090	R622	R-CHIP	10KOHM, 5%, 1/16W, DA, TP, 1608
2007-000090	R653	R-CHIP	10KOHM, 5%, 1/16W, DA, TP, 1608
2007-000090	R654	R-CHIP	10KOHM, 5%, 1/16W, DA, TP, 1608
2007-000090	R655	R-CHIP	10KOHM, 5%, 1/16W, DA, TP, 1608
2007-000090	R656	R-CHIP	10KOHM, 5%, 1/16W, DA, TP, 1608
2007-000090	R657	R-CHIP	10KOHM, 5%, 1/16W, DA, TP, 1608
2007-000090	R658	R-CHIP	10KOHM, 5%, 1/16W, DA, TP, 1608
2007-000090	R659	R-CHIP	10KOHM, 5%, 1/16W, DA, TP, 1608
2007-000090	R661	R-CHIP	10KOHM, 5%, 1/16W, DA, TP, 1608
2007-000090	R676	R-CHIP	10KOHM, 5%, 1/16W, DA, TP, 1608
2007-000090	R677	R-CHIP	10KOHM, 5%, 1/16W, DA, TP, 1608
2007-000090	R678	R-CHIP	10KOHM, 5%, 1/16W, DA, TP, 1608
2007-000090	R684	R-CHIP	10KOHM, 5%, 1/16W, DA, TP, 1608
2007-000090	R823	R-CHIP	10KOHM, 5%, 1/16W, DA, TP, 1608
2007-000090	R824	R-CHIP	10KOHM, 5%, 1/16W, DA, TP, 1608
2007-000090	R873	R-CHIP	10KOHM, 5%, 1/16W, DA, TP, 1608
2007-000091	R4560	R-CHIP	12Kohm, 5%, 1/16W, DA, TP, 1608
2007-000091	R4561	R-CHIP	12Kohm, 5%, 1/16W, DA, TP, 1608
2007-000091	R4562	R-CHIP	12Kohm, 5%, 1/16W, DA, TP, 1608
2007-000091	R4563	R-CHIP	12Kohm, 5%, 1/16W, DA, TP, 1608
2007-000092	R4568	R-CHIP	15Kohm, 5%, 1/16W, DA, TP, 1608
2007-000092	R4569	R-CHIP	15Kohm, 5%, 1/16W, DA, TP, 1608
2007-000093	R312	R-CHIP	20Kohm, 5%, 1/16W, DA, TP, 1608
2007-000097	R608	R-CHIP	47Kohm, 5%, 1/16W, DA, TP, 1608
2007-000098	R690	R-CHIP	56Kohm, 5%, 1/16W, DA, TP, 1608
2007-000102	R553	R-CHIP	100Kohm, 5%, 1/16W, DA, TP, 1608
2007-000102	R554	R-CHIP	100Kohm, 5%, 1/16W, DA, TP, 1608
2007-000102	R874	R-CHIP	100Kohm, 5%, 1/16W, DA, TP, 1608
2007-000107	R404	R-CHIP	470Kohm, 5%, 1/16W, DA, TP, 1608
2007-000109	R305	R-CHIP	1Mohm, 5%, 1/16W, DA, TP, 1608
2007-000109	R309	R-CHIP	1Mohm, 5%, 1/16W, DA, TP, 1608
2007-000109	R317	R-CHIP	1Mohm, 5%, 1/16W, DA, TP, 1608
2007-000113	R201	R-CHIP	33ohm, 5%, 1/16W, DA, TP, 1608
2007-000113	R202	R-CHIP	33ohm, 5%, 1/16W, DA, TP, 1608
2007-000113	R203	R-CHIP	33ohm, 5%, 1/16W, DA, TP, 1608
2007-000113	R204	R-CHIP	33ohm, 5%, 1/16W, DA, TP, 1608
2007-000113	R205	R-CHIP	33ohm, 5%, 1/16W, DA, TP, 1608
2007-000113	R206	R-CHIP	33ohm, 5%, 1/16W, DA, TP, 1608
2007-000113	R207	R-CHIP	33ohm, 5%, 1/16W, DA, TP, 1608
2007-000113	R219	R-CHIP	33ohm, 5%, 1/16W, DA, TP, 1608
2007-000116	R238	R-CHIP	120ohm, 5%, 1/16W, DA, TP, 1608
2007-000116	R4007	R-CHIP	120ohm, 5%, 1/16W, DA, TP, 1608
2007-000116	R906	R-CHIP	120ohm, 5%, 1/16W, DA, TP, 1608
2007-000118	R235	R-CHIP	390ohm, 5%, 1/16W, DA, TP, 1608
2007-000119	R4556	R-CHIP	560ohm, 5%, 1/16W, DA, TP, 1608
2007-000119	R4557	R-CHIP	560ohm, 5%, 1/16W, DA, TP, 1608
2007-000119	R4558	R-CHIP	560ohm, 5%, 1/16W, DA, TP, 1608
2007-000119	R4559	R-CHIP	560ohm, 5%, 1/16W, DA, TP, 1608
2007-000120	R645	R-CHIP	680ohm, 5%, 1/16W, DA, TP, 1608
2007-000123	R01	R-CHIP	1.5Kohm, 5%, 1/16W, DA, TP, 1608
2007-000124	R944	R-CHIP	2.2Kohm, 5%, 1/16W, DA, TP, 1608
2007-000134	R511	R-CHIP	33Kohm, 5%, 1/16W, DA, TP, 1608
2007-000134	R539	R-CHIP	33Kohm, 5%, 1/16W, DA, TP, 1608
2007-000219	R806	R-CHIP	1.2Kohm, 1%, 1/16W, DA, TP, 1608
2007-000219	R809	R-CHIP	1.2Kohm, 1%, 1/16W, DA, TP, 1608
2007-000239	R612	R-CHIP	1.5Kohm, 1%, 1/16W, DA, TP, 1608

2007-000239	R613	R-CHIP	1.5Kohm, 1%, 1/16W, DA, TP, 1608
2007-000309	R214	R-CHIP	10ohm, 5%, 1/16W, DA, TP, 1608
2007-000309	R215	R-CHIP	10ohm, 5%, 1/16W, DA, TP, 1608
2007-000309	R224	R-CHIP	10ohm, 5%, 1/16W, DA, TP, 1608
2007-000309	R692	R-CHIP	10ohm, 5%, 1/16W, DA, TP, 1608
2007-000309	R693	R-CHIP	10ohm, 5%, 1/16W, DA, TP, 1608
2007-000309	RJ15	R-CHIP	10ohm, 5%, 1/16W, DA, TP, 1608
2007-000309	RJ16	R-CHIP	10ohm, 5%, 1/16W, DA, TP, 1608
2007-000309	RJ17	R-CHIP	10ohm, 5%, 1/16W, DA, TP, 1608
2007-000402	R610	R-CHIP	150ohm, 5%, 1/16W, DA, TP, 1608
2007-000402	R611	R-CHIP	150ohm, 5%, 1/16W, DA, TP, 1608
2007-000402	R620	R-CHIP	150ohm, 5%, 1/16W, DA, TP, 1608
2007-000402	R943	R-CHIP	150ohm, 5%, 1/16W, DA, TP, 1608
2007-000616	R318	R-CHIP	24Kohm, 5%, 1/16W, DA, TP, 1608
2007-000701	R810	R-CHIP	3.6Kohm, 1%, 1/16W, DA, TP, 1608
2007-000882	R4571	R-CHIP	4.7ohm, 5%, 1/16W, DA, TP, 1608
2007-000882	R4572	R-CHIP	4.7ohm, 5%, 1/16W, DA, TP, 1608
2007-001039	R602	R-CHIP	56KOHM, 5%, 1/10W, DA, TP, 2012
2007-001114	R4008	R-CHIP	680Kohm, 5%, 1/16W, DA, TP, 1608
2007-001164	R307	R-CHIP	75ohm, 1%, 1/16W, DA, TP, 1608
2007-001164	R308	R-CHIP	75ohm, 1%, 1/16W, DA, TP, 1608
2007-001164	R310	R-CHIP	75ohm, 1%, 1/16W, DA, TP, 1608
2007-001164	R311	R-CHIP	75ohm, 1%, 1/16W, DA, TP, 1608
2007-001164	R313	R-CHIP	75ohm, 1%, 1/16W, DA, TP, 1608
2007-001164	R319	R-CHIP	75ohm, 1%, 1/16W, DA, TP, 1608
2007-001167	R236	R-CHIP	75ohm, 5%, 1/16W, DA, TP, 1608
2007-001167	R401	R-CHIP	75ohm, 5%, 1/16W, DA, TP, 1608
2007-001167	R402	R-CHIP	75ohm, 5%, 1/16W, DA, TP, 1608
2007-001167	R403	R-CHIP	75ohm, 5%, 1/16W, DA, TP, 1608
2007-001167	R619	R-CHIP	75ohm, 5%, 1/16W, DA, TP, 1608
2007-008433	R4570	R-CHIP	0.330HM, 1%, 1W, DA, TP, 6432
2007-008433	R805	R-CHIP	0.330HM, 1%, 1W, DA, TP, 6432
2007-008433	R808	R-CHIP	0.330HM, 1%, 1W, DA, TP, 6432
2011-000002	RA301	R-NETWORK	22ohm, 5%, 63mW, L, CHIP, 8P, TP
2011-000002	RA302	R-NETWORK	22ohm, 5%, 63mW, L, CHIP, 8P, TP
2011-000002	RA303	R-NETWORK	22ohm, 5%, 63mW, L, CHIP, 8P, TP
2011-000002	RA304	R-NETWORK	22ohm, 5%, 63mW, L, CHIP, 8P, TP
2011-000002	RA305	R-NETWORK	22ohm, 5%, 63mW, L, CHIP, 8P, TP
2011-000002	RA306	R-NETWORK	22ohm, 5%, 63mW, L, CHIP, 8P, TP
2011-000515	RA610	R-NETWORK	4.7Kohm, 5%, 1/16W, L, CHIP, 8P, TP
2011-000515	RA611	R-NETWORK	4.7Kohm, 5%, 1/16W, L, CHIP, 8P, TP
2011-000651	RA601	R-NETWORK	10ohm, 5%, 63mW, L, CHIP, 8P, TP
2011-000651	RA602	R-NETWORK	10ohm, 5%, 63mW, L, CHIP, 8P, TP
2011-000651	RA603	R-NETWORK	10ohm, 5%, 63mW, L, CHIP, 8P, TP
2011-000651	RA604	R-NETWORK	10ohm, 5%, 63mW, L, CHIP, 8P, TP
2011-000651	RA605	R-NETWORK	10ohm, 5%, 63mW, L, CHIP, 8P, TP
2011-000651	RA606	R-NETWORK	10ohm, 5%, 63mW, L, CHIP, 8P, TP
2011-000651	RA607	R-NETWORK	10ohm, 5%, 63mW, L, CHIP, 8P, TP
2011-000651	RA608	R-NETWORK	10ohm, 5%, 63mW, L, CHIP, 8P, TP
2011-000651	RA609	R-NETWORK	10ohm, 5%, 63mW, L, CHIP, 8P, TP
2203-000140	C538	C-CERAMIC, CHIP	1.5nF, 10%, 50V, X7R, TP, 1608, -
2203-000140	C574	C-CERAMIC, CHIP	1.5nF, 10%, 50V, X7R, TP, 1608, -
2203-000189	C338	C-CERAMIC, CHIP	100nF, +80-20%, 25V, Y5V, TP, 1608,
2203-000189	C3503	C-CERAMIC, CHIP	100nF, +80-20%, 25V, Y5V, TP, 1608,
2203-000189	C559	C-CERAMIC, CHIP	100nF, +80-20%, 25V, Y5V, TP, 1608,
2203-000189	C565	C-CERAMIC, CHIP	100nF, +80-20%, 25V, Y5V, TP, 1608,
2203-000189	C620	C-CERAMIC, CHIP	100nF, +80-20%, 25V, Y5V, TP, 1608,
2203-000189	C624	C-CERAMIC, CHIP	100nF, +80-20%, 25V, Y5V, TP, 1608,
2203-000189	C844	C-CERAMIC, CHIP	100nF, +80-20%, 25V, Y5V, TP, 1608,

2203-000815	C9561	C-CERAMIC,CHIP	0.033nF,5%,50V,NPO,TP,1608
2203-000815	C9582	C-CERAMIC,CHIP	0.033nF,5%,50V,NPO,TP,1608
2203-000843	C379	C-CERAMIC,CHIP	39nF,10%,25V,X7R,TP,1608,-
2203-000972	C576	C-CERAMIC,CHIP	47nF,10%,16V,X7R,TP,1608
2203-000998	C306	C-CERAMIC,CHIP	0.047nF,5%,50V,NPO,TP,1608
2203-000998	C307	C-CERAMIC,CHIP	0.047nF,5%,50V,NPO,TP,1608
2203-000998	C3302	C-CERAMIC,CHIP	0.047nF,5%,50V,NPO,TP,1608
2203-001077	C567	C-CERAMIC,CHIP	0.056nF,5%,50V,NPO,TP,2012
2203-001077	C568	C-CERAMIC,CHIP	0.056nF,5%,50V,NPO,TP,2012
2203-001077	C571	C-CERAMIC,CHIP	0.056nF,5%,50V,NPO,TP,2012
2203-001077	C9572	C-CERAMIC,CHIP	0.056nF,5%,50V,NPO,TP,2012
2203-001077	C9573	C-CERAMIC,CHIP	0.056nF,5%,50V,NPO,TP,2012
2203-001077	C9574	C-CERAMIC,CHIP	0.056nF,5%,50V,NPO,TP,2012
2203-001077	C9575	C-CERAMIC,CHIP	0.056nF,5%,50V,NPO,TP,2012
2203-001607	C608	C-CERAMIC,CHIP	0.22nF,5%,50V,NPO,TP,1608
2203-001630	C9594	C-CERAMIC,CHIP	330nF,+80-20%,16V,Y5V,TP,1608
2203-001630	C9595	C-CERAMIC,CHIP	330nF,+80-20%,16V,Y5V,TP,1608
2203-001656	C404	C-CERAMIC,CHIP	0.47nF,5%,50V,NPO,TP,1608
2203-001656	C543	C-CERAMIC,CHIP	0.47nF,5%,50V,NPO,TP,1608
2203-001656	C569	C-CERAMIC,CHIP	0.47nF,5%,50V,NPO,TP,1608
2203-001656	C9564	C-CERAMIC,CHIP	0.47nF,5%,50V,NPO,TP,1608
2203-001656	C9565	C-CERAMIC,CHIP	0.47nF,5%,50V,NPO,TP,1608
2203-005005	C214	C-CERAMIC,CHIP	100nF,10%,16V,X7R,TP,1608
2203-005005	C215	C-CERAMIC,CHIP	100nF,10%,16V,X7R,TP,1608
2203-005005	C216	C-CERAMIC,CHIP	100nF,10%,16V,X7R,TP,1608
2203-005005	C217	C-CERAMIC,CHIP	100nF,10%,16V,X7R,TP,1608
2203-005005	C229	C-CERAMIC,CHIP	100nF,10%,16V,X7R,TP,1608
2203-005005	C238	C-CERAMIC,CHIP	100nF,10%,16V,X7R,TP,1608
2203-005005	C245	C-CERAMIC,CHIP	100nF,10%,16V,X7R,TP,1608
2203-005005	C249	C-CERAMIC,CHIP	100nF,10%,16V,X7R,TP,1608
2203-005005	C267	C-CERAMIC,CHIP	100nF,10%,16V,X7R,TP,1608
2203-005005	C274	C-CERAMIC,CHIP	100nF,10%,16V,X7R,TP,1608
2203-005005	C275	C-CERAMIC,CHIP	100nF,10%,16V,X7R,TP,1608
2203-005005	C276	C-CERAMIC,CHIP	100nF,10%,16V,X7R,TP,1608
2203-005005	C277	C-CERAMIC,CHIP	100nF,10%,16V,X7R,TP,1608
2203-005005	C278	C-CERAMIC,CHIP	100nF,10%,16V,X7R,TP,1608
2203-005005	C279	C-CERAMIC,CHIP	100nF,10%,16V,X7R,TP,1608
2203-005005	C282	C-CERAMIC,CHIP	100nF,10%,16V,X7R,TP,1608
2203-005005	C302	C-CERAMIC,CHIP	100nF,10%,16V,X7R,TP,1608
2203-005005	C303	C-CERAMIC,CHIP	100nF,10%,16V,X7R,TP,1608
2203-005005	C305	C-CERAMIC,CHIP	100nF,10%,16V,X7R,TP,1608
2203-005005	C318	C-CERAMIC,CHIP	100nF,10%,16V,X7R,TP,1608
2203-005005	C319	C-CERAMIC,CHIP	100nF,10%,16V,X7R,TP,1608
2203-005005	C321	C-CERAMIC,CHIP	100nF,10%,16V,X7R,TP,1608
2203-005005	C322	C-CERAMIC,CHIP	100nF,10%,16V,X7R,TP,1608
2203-005005	C323	C-CERAMIC,CHIP	100nF,10%,16V,X7R,TP,1608
2203-005005	C327	C-CERAMIC,CHIP	100nF,10%,16V,X7R,TP,1608
2203-005005	C328	C-CERAMIC,CHIP	100nF,10%,16V,X7R,TP,1608
2203-005005	C3303	C-CERAMIC,CHIP	100nF,10%,16V,X7R,TP,1608
2203-005005	C3304	C-CERAMIC,CHIP	100nF,10%,16V,X7R,TP,1608
2203-005005	C3305	C-CERAMIC,CHIP	100nF,10%,16V,X7R,TP,1608
2203-005005	C3306	C-CERAMIC,CHIP	100nF,10%,16V,X7R,TP,1608
2203-005005	C3307	C-CERAMIC,CHIP	100nF,10%,16V,X7R,TP,1608
2203-005005	C3308	C-CERAMIC,CHIP	100nF,10%,16V,X7R,TP,1608
2203-005005	C3309	C-CERAMIC,CHIP	100nF,10%,16V,X7R,TP,1608
2203-005005	C331	C-CERAMIC,CHIP	100nF,10%,16V,X7R,TP,1608
2203-005005	C3311	C-CERAMIC,CHIP	100nF,10%,16V,X7R,TP,1608
2203-005005	C3312	C-CERAMIC,CHIP	100nF,10%,16V,X7R,TP,1608
2203-005005	C3313	C-CERAMIC,CHIP	100nF,10%,16V,X7R,TP,1608

2203-005005	C406	C-CERAMIC,CHIP	100nF,10%,16V,X7R,TP,1608
2203-005005	C485	C-CERAMIC,CHIP	100nF,10%,16V,X7R,TP,1608
2203-005005	C486	C-CERAMIC,CHIP	100nF,10%,16V,X7R,TP,1608
2203-005005	C492	C-CERAMIC,CHIP	100nF,10%,16V,X7R,TP,1608
2203-005005	C549	C-CERAMIC,CHIP	100nF,10%,16V,X7R,TP,1608
2203-005005	C551	C-CERAMIC,CHIP	100nF,10%,16V,X7R,TP,1608
2203-005005	C589	C-CERAMIC,CHIP	100nF,10%,16V,X7R,TP,1608
2203-005005	C601	C-CERAMIC,CHIP	100nF,10%,16V,X7R,TP,1608
2203-005005	C602	C-CERAMIC,CHIP	100nF,10%,16V,X7R,TP,1608
2203-005005	C605	C-CERAMIC,CHIP	100nF,10%,16V,X7R,TP,1608
2203-005005	C606	C-CERAMIC,CHIP	100nF,10%,16V,X7R,TP,1608
2203-005005	C607	C-CERAMIC,CHIP	100nF,10%,16V,X7R,TP,1608
2203-005005	C609	C-CERAMIC,CHIP	100nF,10%,16V,X7R,TP,1608
2203-005005	C613	C-CERAMIC,CHIP	100nF,10%,16V,X7R,TP,1608
2203-005005	C619	C-CERAMIC,CHIP	100nF,10%,16V,X7R,TP,1608
2203-005005	C625	C-CERAMIC,CHIP	100nF,10%,16V,X7R,TP,1608
2203-005005	C626	C-CERAMIC,CHIP	100nF,10%,16V,X7R,TP,1608
2203-005005	C824	C-CERAMIC,CHIP	100nF,10%,16V,X7R,TP,1608
2203-005005	C873	C-CERAMIC,CHIP	100nF,10%,16V,X7R,TP,1608
2203-005005	C874	C-CERAMIC,CHIP	100nF,10%,16V,X7R,TP,1608
2203-005005	C875	C-CERAMIC,CHIP	100nF,10%,16V,X7R,TP,1608
2203-005005	C884	C-CERAMIC,CHIP	100nF,10%,16V,X7R,TP,1608
2203-005005	C886	C-CERAMIC,CHIP	100nF,10%,16V,X7R,TP,1608
2203-005005	C912	C-CERAMIC,CHIP	100nF,10%,16V,X7R,TP,1608
2203-005005	C917	C-CERAMIC,CHIP	100nF,10%,16V,X7R,TP,1608
2203-005005	C9562	C-CERAMIC,CHIP	100nF,10%,16V,X7R,TP,1608
2203-005005	C9563	C-CERAMIC,CHIP	100nF,10%,16V,X7R,TP,1608
2203-005005	C9585	C-CERAMIC,CHIP	100nF,10%,16V,X7R,TP,1608
2203-005005	C9587	C-CERAMIC,CHIP	100nF,10%,16V,X7R,TP,1608
2203-005005	C9588	C-CERAMIC,CHIP	100nF,10%,16V,X7R,TP,1608
2203-005005	C9589	C-CERAMIC,CHIP	100nF,10%,16V,X7R,TP,1608
2203-005005	C9590	C-CERAMIC,CHIP	100nF,10%,16V,X7R,TP,1608
2203-005005	C9591	C-CERAMIC,CHIP	100nF,10%,16V,X7R,TP,1608
2203-005005	C9592	C-CERAMIC,CHIP	100nF,10%,16V,X7R,TP,1608
2203-005005	U118	C-CERAMIC,CHIP	100nF,10%,16V,X7R,TP,1608
2203-005005	U124	C-CERAMIC,CHIP	100nF,10%,16V,X7R,TP,1608
2203-005005	U125	C-CERAMIC,CHIP	100nF,10%,16V,X7R,TP,1608
2203-005005	U126	C-CERAMIC,CHIP	100nF,10%,16V,X7R,TP,1608
2203-005065	C261	C-CERAMIC,CHIP	1000nF,+80-20%,10V,Y5V,TP,1608
2203-005065	C264	C-CERAMIC,CHIP	1000nF,+80-20%,10V,Y5V,TP,1608
2203-005065	C988	C-CERAMIC,CHIP	1000nF,+80-20%,10V,Y5V,TP,1608
2203-005065	C989	C-CERAMIC,CHIP	1000nF,+80-20%,10V,Y5V,TP,1608
2203-006017	C221	C-CERAMIC,CHIP	0.56NF,5%,50V,COG,TP,1608
2203-006017	C224	C-CERAMIC,CHIP	0.56NF,5%,50V,COG,TP,1608
2402-000108	C3405	C-AL,SMD	10uF,20%,16V,WT,TP,4.3x4.3x5.4
2402-000108	C3406	C-AL,SMD	10uF,20%,16V,WT,TP,4.3x4.3x5.4
2402-000108	C3407	C-AL,SMD	10uF,20%,16V,WT,TP,4.3x4.3x5.4
2402-000108	C488	C-AL,SMD	10uF,20%,16V,WT,TP,4.3x4.3x5.4
2402-000108	C489	C-AL,SMD	10uF,20%,16V,WT,TP,4.3x4.3x5.4
2402-000108	C491	C-AL,SMD	10uF,20%,16V,WT,TP,4.3x4.3x5.4
2402-000108	C552	C-AL,SMD	10uF,20%,16V,WT,TP,4.3x4.3x5.4
2402-000108	C561	C-AL,SMD	10uF,20%,16V,WT,TP,4.3x4.3x5.4
2402-000108	C622	C-AL,SMD	10uF,20%,16V,WT,TP,4.3x4.3x5.4
2402-000135	C218	C-AL,SMD	22uF,20%,16V,GP,TP,5.3x5.3x5.4
2402-000135	C223	C-AL,SMD	22uF,20%,16V,GP,TP,5.3x5.3x5.4
2402-000135	C236	C-AL,SMD	22uF,20%,16V,GP,TP,5.3x5.3x5.4
2402-000135	C250	C-AL,SMD	22uF,20%,16V,GP,TP,5.3x5.3x5.4
2402-000135	C251	C-AL,SMD	22uF,20%,16V,GP,TP,5.3x5.3x5.4
2402-000135	C252	C-AL,SMD	22uF,20%,16V,GP,TP,5.3x5.3x5.4

2402-000135	C254	C-AL, SMD	22uF, 20%, 16V, GP, TP, 5.3x5.3x5.4
2402-000135	C258	C-AL, SMD	22uF, 20%, 16V, GP, TP, 5.3x5.3x5.4
2402-000135	C269	C-AL, SMD	22uF, 20%, 16V, GP, TP, 5.3x5.3x5.4
2402-000135	C339	C-AL, SMD	22uF, 20%, 16V, GP, TP, 5.3x5.3x5.4
2402-000135	C345	C-AL, SMD	22uF, 20%, 16V, GP, TP, 5.3x5.3x5.4
2402-000135	C411	C-AL, SMD	22uF, 20%, 16V, GP, TP, 5.3x5.3x5.4
2402-000135	C575	C-AL, SMD	22uF, 20%, 16V, GP, TP, 5.3x5.3x5.4
2402-000135	C828	C-AL, SMD	22uF, 20%, 16V, GP, TP, 5.3x5.3x5.4
2402-000135	C904	C-AL, SMD	22uF, 20%, 16V, GP, TP, 5.3x5.3x5.4
2402-000135	C906	C-AL, SMD	22uF, 20%, 16V, GP, TP, 5.3x5.3x5.4
2402-000135	C907	C-AL, SMD	22uF, 20%, 16V, GP, TP, 5.3x5.3x5.4
2402-000135	C9556	C-AL, SMD	22uF, 20%, 16V, GP, TP, 5.3x5.3x5.4
2402-000135	C9557	C-AL, SMD	22uF, 20%, 16V, GP, TP, 5.3x5.3x5.4
2402-000135	C9558	C-AL, SMD	22uF, 20%, 16V, GP, TP, 5.3x5.3x5.4
2402-000135	U120	C-AL, SMD	22uF, 20%, 16V, GP, TP, 5.3x5.3x5.4
2402-000135	U121	C-AL, SMD	22uF, 20%, 16V, GP, TP, 5.3x5.3x5.4
2402-000170	C3404	C-AL, SMD	1uF, 20%, 50V, GP, TP, 4.3x4.3x5.4
2402-000170	C343	C-AL, SMD	1uF, 20%, 50V, GP, TP, 4.3x4.3x5.4
2402-000170	C346	C-AL, SMD	1uF, 20%, 50V, GP, TP, 4.3x4.3x5.4
2402-000170	C350	C-AL, SMD	1uF, 20%, 50V, GP, TP, 4.3x4.3x5.4
2402-000170	C351	C-AL, SMD	1uF, 20%, 50V, GP, TP, 4.3x4.3x5.4
2402-000170	C358	C-AL, SMD	1uF, 20%, 50V, GP, TP, 4.3x4.3x5.4
2402-000170	C503	C-AL, SMD	1uF, 20%, 50V, GP, TP, 4.3x4.3x5.4
2402-000170	C612	C-AL, SMD	1uF, 20%, 50V, GP, TP, 4.3x4.3x5.4
2402-000170	C870	C-AL, SMD	1uF, 20%, 50V, GP, TP, 4.3x4.3x5.4
2402-000170	U116	C-AL, SMD	1uF, 20%, 50V, GP, TP, 4.3x4.3x5.4
2402-000173	C553	C-AL, SMD	4.7uF, 20%, 35V, GP, TP, 4.3x4.3x5.4
2402-000173	C554	C-AL, SMD	4.7uF, 20%, 35V, GP, TP, 4.3x4.3x5.4
2402-000173	C555	C-AL, SMD	4.7uF, 20%, 35V, GP, TP, 4.3x4.3x5.4
2402-000173	C556	C-AL, SMD	4.7uF, 20%, 35V, GP, TP, 4.3x4.3x5.4
2402-000173	C557	C-AL, SMD	4.7uF, 20%, 35V, GP, TP, 4.3x4.3x5.4
2402-000173	C563	C-AL, SMD	4.7uF, 20%, 35V, GP, TP, 4.3x4.3x5.4
2402-000173	C564	C-AL, SMD	4.7uF, 20%, 35V, GP, TP, 4.3x4.3x5.4
2402-000176	C502	C-AL, SMD	10uF, 20%, 16V, GP, TP, 4.3x4.3x5.4
2402-000176	C545	C-AL, SMD	10uF, 20%, 16V, GP, TP, 4.3x4.3x5.4
2402-000176	C546	C-AL, SMD	10uF, 20%, 16V, GP, TP, 4.3x4.3x5.4
2402-000176	C566	C-AL, SMD	10uF, 20%, 16V, GP, TP, 4.3x4.3x5.4
2402-000179	C311	C-AL, SMD	47uF, 20%, 16V, GP, TP, 6.6x6.6x5.4
2402-000179	C497	C-AL, SMD	47uF, 20%, 16V, GP, TP, 6.6x6.6x5.4
2402-000179	C577	C-AL, SMD	47uF, 20%, 16V, GP, TP, 6.6x6.6x5.4
2402-000179	C603	C-AL, SMD	47uF, 20%, 16V, GP, TP, 6.6x6.6x5.4
2402-000179	C611	C-AL, SMD	47uF, 20%, 16V, GP, TP, 6.6x6.6x5.4
2402-000179	C9559	C-AL, SMD	47uF, 20%, 16V, GP, TP, 6.6x6.6x5.4
2402-000209	C231	C-AL, SMD	22uF, 20%, 16V, WT, TP, 5.3x5.3mm, 1
2402-000209	C241	C-AL, SMD	22uF, 20%, 16V, WT, TP, 5.3x5.3mm, 1
2402-000209	C284	C-AL, SMD	22uF, 20%, 16V, WT, TP, 5.3x5.3mm, 1
2402-000209	C285	C-AL, SMD	22uF, 20%, 16V, WT, TP, 5.3x5.3mm, 1
2402-000209	C903	C-AL, SMD	22uF, 20%, 16V, WT, TP, 5.3x5.3mm, 1
2402-000209	C916	C-AL, SMD	22uF, 20%, 16V, WT, TP, 5.3x5.3mm, 1
2402-000209	C9560	C-AL, SMD	22uF, 20%, 16V, WT, TP, 5.3x5.3mm, 1
2402-001018	C504	C-AL, SMD	470nF, 20%, 50V, GP, TP, 4.3x4.3x5.4
2402-001018	C505	C-AL, SMD	470nF, 20%, 50V, GP, TP, 4.3x4.3x5.4
2402-001019	C616	C-AL, SMD	2.2uF, 20%, 35V, GP, TP, 3.3x3.3x5.4
2402-001042	C041	C-AL, SMD	100uF, 20%, 16V, GP, TP, 6.6x6.6x5.4mm
2402-001042	C247	C-AL, SMD	100uF, 20%, 16V, GP, TP, 6.6x6.6x5.4mm
2402-001042	C281	C-AL, SMD	100uF, 20%, 16V, GP, TP, 6.6x6.6x5.4mm
2402-001042	C336	C-AL, SMD	100uF, 20%, 16V, GP, TP, 6.6x6.6x5.4mm
2402-001042	C382	C-AL, SMD	100uF, 20%, 16V, GP, TP, 6.6x6.6x5.4mm
2402-001042	C392	C-AL, SMD	100uF, 20%, 16V, GP, TP, 6.6x6.6x5.4mm

2402-001042	C405	C-AL,SMD	100uF,20%,16V,GP,TP,6.6x6.6x5.4mm
2402-001042	C535	C-AL,SMD	100uF,20%,16V,GP,TP,6.6x6.6x5.4mm
2402-001042	C604	C-AL,SMD	100uF,20%,16V,GP,TP,6.6x6.6x5.4mm
2402-001042	C621	C-AL,SMD	100uF,20%,16V,GP,TP,6.6x6.6x5.4mm
2402-001042	C809	C-AL,SMD	100uF,20%,16V,GP,TP,6.6x6.6x5.4mm
2402-001042	C847	C-AL,SMD	100uF,20%,16V,GP,TP,6.6x6.6x5.4mm
2402-001042	C861	C-AL,SMD	100uF,20%,16V,GP,TP,6.6x6.6x5.4mm
2402-001042	C891	C-AL,SMD	100uF,20%,16V,GP,TP,6.6x6.6x5.4mm
2402-001042	C892	C-AL,SMD	100uF,20%,16V,GP,TP,6.6x6.6x5.4mm
2402-001042	C895	C-AL,SMD	100uF,20%,16V,GP,TP,6.6x6.6x5.4mm
2402-001042	U127	C-AL,SMD	100uF,20%,16V,GP,TP,6.6x6.6x5.4mm
2402-001086	C9567	C-AL,SMD	100UF,20%,16V,WT,TP,6.6X6.6X5.3
2402-001086	U128	C-AL,SMD	100UF,20%,16V,WT,TP,6.6X6.6X5.3
2402-001128	C845	C-AL,SMD	100UF,20%,16V,WT,TP,6.3X5.7MM
2402-001128	C851	C-AL,SMD	100UF,20%,16V,WT,TP,6.3X5.7MM
2402-001128	C857	C-AL,SMD	100UF,20%,16V,WT,TP,6.3X5.7MM
2402-001128	C898	C-AL,SMD	100UF,20%,16V,WT,TP,6.3X5.7MM
2402-001155	C200	C-AL,SMD	47UF,20%,16V,WT,TP,6.3X5.2MM
2402-001155	C288	C-AL,SMD	47UF,20%,16V,WT,TP,6.3X5.2MM
2402-001155	C289	C-AL,SMD	47UF,20%,16V,WT,TP,6.3X5.2MM
2402-001155	C329	C-AL,SMD	47UF,20%,16V,WT,TP,6.3X5.2MM
2409-001046	C816	C-ORGANIC	39UF,20%,16V,WT,TP,6.3X6 MM,-
2409-001049	C810	C-ORGANIC	47UF,20%,6.3V,FX,TP,5X5.9MM,-
2409-001049	C813	C-ORGANIC	47UF,20%,6.3V,FX,TP,5X5.9MM,-
2409-001049	C815	C-ORGANIC	47UF,20%,6.3V,FX,TP,5X5.9MM,-
2409-001049	C818	C-ORGANIC	47UF,20%,6.3V,FX,TP,5X5.9MM,-
2409-001049	C827	C-ORGANIC	47UF,20%,6.3V,FX,TP,5X5.9MM,-
2409-001049	C865	C-ORGANIC	47UF,20%,6.3V,FX,TP,5X5.9MM,-
2409-001049	C867	C-ORGANIC	47UF,20%,6.3V,FX,TP,5X5.9MM,-
2409-001049	C869	C-ORGANIC	47UF,20%,6.3V,FX,TP,5X5.9MM,-
2409-001049	C876	C-ORGANIC	47UF,20%,6.3V,FX,TP,5X5.9MM,-
2409-001049	C890	C-ORGANIC	47UF,20%,6.3V,FX,TP,5X5.9MM,-
2409-001049	U129	C-ORGANIC	47UF,20%,6.3V,FX,TP,5X5.9MM,-
2503-001018	CA300	C-NETWORK	15PFx4,10%,50V,-
2503-001018	CA301	C-NETWORK	15PFx4,10%,50V,-
2503-001018	CA302	C-NETWORK	15PFx4,10%,50V,-
2503-001018	CA303	C-NETWORK	15PFx4,10%,50V,-
2503-001018	CA304	C-NETWORK	15PFx4,10%,50V,-
2503-001018	CA305	C-NETWORK	15PFx4,10%,50V,-
2703-000398	L008	INDUCTOR-SMD	10uH,10%,3.2x2.5x2.2mm
2703-001778	L201	INDUCTOR-SMD	3.3UH,20%,3.2X2.5X2.2MM
2703-001778	L202	INDUCTOR-SMD	3.3UH,20%,3.2X2.5X2.2MM
2703-001778	L203	INDUCTOR-SMD	3.3UH,20%,3.2X2.5X2.2MM
2703-001778	L204	INDUCTOR-SMD	3.3UH,20%,3.2X2.5X2.2MM
2703-001778	L205	INDUCTOR-SMD	3.3UH,20%,3.2X2.5X2.2MM
2703-001778	L206	INDUCTOR-SMD	3.3UH,20%,3.2X2.5X2.2MM
2703-001778	L207	INDUCTOR-SMD	3.3UH,20%,3.2X2.5X2.2MM
2703-001778	L208	INDUCTOR-SMD	3.3UH,20%,3.2X2.5X2.2MM
2703-001778	L301	INDUCTOR-SMD	3.3UH,20%,3.2X2.5X2.2MM
2703-001778	L555	INDUCTOR-SMD	3.3UH,20%,3.2X2.5X2.2MM
2703-002327	L540	INDUCTOR-SMD	3.9UH,55,3.2X2.5X2.2MM
2703-002327	L541	INDUCTOR-SMD	3.9UH,55,3.2X2.5X2.2MM
2704-000001	FT925	INDUCTOR-SMD-ARRAY	4000HM,50V,0.5A,-,0.30HM,-25T085C
2704-000001	FT926	INDUCTOR-SMD-ARRAY	4000HM,50V,0.5A,-,0.30HM,-25T085C
2704-000001	FT933	INDUCTOR-SMD-ARRAY	4000HM,50V,0.5A,-,0.30HM,-25T085C
2704-000001	FT934	INDUCTOR-SMD-ARRAY	4000HM,50V,0.5A,-,0.30HM,-25T085C
2704-000004	FT935	INDUCTOR-SMD-ARRAY	2000HM,50V,0.5A,-,0.20HM,-25T085C
2801-003667	X201	CRYSTAL-SMD	14.3182MHZ,50PPM,28-AAN,16,500HM,TP
2801-003843	X511	CRYSTAL-SMD	18.432MHz,30ppm,28-AAN,20pF,50ohm,TP

2801-004117	X601	CRYSTAL-SMD	6MHZ,30PPM,28-ABX,20PF,1500HM,TP	
2901-001114	F187	FILTER-EMI SMD	25VDC,2.0ADC,-,100nF,3.2x1.6x1	
2901-001114	FT214	FILTER-EMI SMD	25VDC,2.0ADC,-,100nF,3.2x1.6x1	
2901-001114	FT281	FILTER-EMI SMD	25VDC,2.0ADC,-,100nF,3.2x1.6x1	
2901-001114	FT401	FILTER-EMI SMD	25VDC,2.0ADC,-,100nF,3.2x1.6x1	
2901-001114	FT901	FILTER-EMI SMD	25VDC,2.0ADC,-,100nF,3.2x1.6x1	
2901-001114	FT902	FILTER-EMI SMD	25VDC,2.0ADC,-,100nF,3.2x1.6x1	
2901-001114	FT903	FILTER-EMI SMD	25VDC,2.0ADC,-,100nF,3.2x1.6x1	
2901-001114	FT904	FILTER-EMI SMD	25VDC,2.0ADC,-,100nF,3.2x1.6x1	
2901-001114	FT923	FILTER-EMI SMD	25VDC,2.0ADC,-,100nF,3.2x1.6x1	
2901-001114	FT924	FILTER-EMI SMD	25VDC,2.0ADC,-,100nF,3.2x1.6x1	
3301-001145	FT201	CORE-FERRITE BEAD	AB,4.5x1.6x1.6mm,-,-	SNA
3301-001145	FT206	CORE-FERRITE BEAD	AB,4.5x1.6x1.6mm,-,-	SNA
3301-001145	FT210	CORE-FERRITE BEAD	AB,4.5x1.6x1.6mm,-,-	SNA
3301-001145	FT211	CORE-FERRITE BEAD	AB,4.5x1.6x1.6mm,-,-	SNA
3301-001145	FT304	CORE-FERRITE BEAD	AB,4.5x1.6x1.6mm,-,-	SNA
3301-001145	FT812	CORE-FERRITE BEAD	AB,4.5x1.6x1.6mm,-,-	SNA
3301-001145	FT813	CORE-FERRITE BEAD	AB,4.5x1.6x1.6mm,-,-	SNA
3301-001145	FT814	CORE-FERRITE BEAD	AB,4.5x1.6x1.6mm,-,-	SNA
3301-001145	FT815	CORE-FERRITE BEAD	AB,4.5x1.6x1.6mm,-,-	SNA
3301-001145	FT816	CORE-FERRITE BEAD	AB,4.5x1.6x1.6mm,-,-	SNA
3301-001145	FT817	CORE-FERRITE BEAD	AB,4.5x1.6x1.6mm,-,-	SNA
3301-001145	FT818	CORE-FERRITE BEAD	AB,4.5x1.6x1.6mm,-,-	SNA
3301-001145	FT821	CORE-FERRITE BEAD	AB,4.5x1.6x1.6mm,-,-	SNA
3301-001145	FT822	CORE-FERRITE BEAD	AB,4.5x1.6x1.6mm,-,-	SNA
3301-001145	FT824	CORE-FERRITE BEAD	AB,4.5x1.6x1.6mm,-,-	SNA
3301-001145	FT825	CORE-FERRITE BEAD	AB,4.5x1.6x1.6mm,-,-	SNA
3301-001145	FT851	CORE-FERRITE BEAD	AB,4.5x1.6x1.6mm,-,-	SNA
3301-001145	FT852	CORE-FERRITE BEAD	AB,4.5x1.6x1.6mm,-,-	SNA
3301-001145	FT877	CORE-FERRITE BEAD	AB,4.5x1.6x1.6mm,-,-	SNA
3301-001145	FT878	CORE-FERRITE BEAD	AB,4.5x1.6x1.6mm,-,-	SNA
3301-001145	FT927	CORE-FERRITE BEAD	AB,4.5x1.6x1.6mm,-,-	SNA
3301-001145	U130	CORE-FERRITE BEAD	AB,4.5x1.6x1.6mm,-,-	SNA
3301-001605	FT928	CORE-FERRITE BEAD	AB,3600HM,2.0X1.2X1.2MM,100MA,TP,FERRITE,0.50HM	SNA
3301-001605	FT929	CORE-FERRITE BEAD	AB,3600HM,2.0X1.2X1.2MM,100MA,TP,FERRITE,0.50HM	SNA
3301-001605	FT930	CORE-FERRITE BEAD	AB,3600HM,2.0X1.2X1.2MM,100MA,TP,FERRITE,0.50HM	SNA
3301-001605	FT931	CORE-FERRITE BEAD	AB,3600HM,2.0X1.2X1.2MM,100MA,TP,FERRITE,0.50HM	SNA
3301-001605	FT932	CORE-FERRITE BEAD	AB,3600HM,2.0X1.2X1.2MM,100MA,TP,FERRITE,0.50HM	SNA
3704-000249	IC620_SOCKET	SOCKET-IC	32P,PLCC,SN,1.27mm	
3711-000556	CN701	CONNECTOR-HEADER	BOX,12P,1R,1.25mm,SMD-A,SN	SNA
3711-000922	CN501	CONNECTOR-HEADER	BOX,4P,1R,1.25mm,SMD-A,SN	
3711-002046	CN512	CONNECTOR-HEADER	3WALL,12P,1R,1.25mm,SMD-S,SN	SNA
3711-002049	CN511	CONNECTOR-HEADER	BOX,6P,1R,1.25mm,SMD-A,SN	SNA
3711-002127	CN754	CONNECTOR-HEADER	BOX,8P,1R,1.25mm,SMD-A,SN	SNA
3711-003161	CN901	CONNECTOR-HEADER	BOX,20P,1R,1.25mm,ANGLE,SN	
3711-004130	CN575	CONNECTOR-HEADER	BOX,31P,2R,0.625mm,SMD-A,AUF	
3711-004933	CN502	CONNECTOR-HEADER	BOX,3P,1R,1.25MM,SMD-A,SN,WHT	SNA
3711-004933	CN706_1	CONNECTOR-HEADER	BOX,3P,1R,1.25MM,SMD-A,SN,WHT	SNA
3711-005154	CN505	CONNECTOR-HEADER	BOX,21P,2R,1.25MM,SMD-A,AUF,BLK	SNA
BN27-00009A	L806	COIL CHOKE	SMD 12X12X6,EOS,33UH,15%,-,0.12 MAX,2A,DR10X5.0MM,18.5TS,12X12X6,1.8MM,1UEW 0.	
BN27-00010A	L801	COIL CHOKE	-,NK17NS,100UH,10%,-,0.7 MAX,6A,DR5.8X4.5MM,59.5TS,6.0X5.2X4.5MM,1.8MM,1UEW 0.	
BN27-00010A	L804	COIL CHOKE	-,NK17NS,100UH,10%,-,0.7 MAX,6A,DR5.8X4.5MM,59.5TS,6.0X5.2X4.5MM,1.8MM,1UEW 0.	
BN27-20001A	L807	COIL-CHOKE	-,53.0UH,20%,DR10*5,-,-,-,0.18ohm,-,-,-,TRAY	
BN27-20001A	L818	COIL-CHOKE	-,53.0UH,20%,DR10*5,-,-,-,0.18ohm,-,-,-,TRAY	
BN41-00169A	MP1.0	PCB MAIN	MB15NOA,FR4,6L,175X181X1.23,MB15NOA	SNA
BN91-00445A	-	ASSY SHIELD	MB15UO	SNA
6003-000117	SH/PCB+C/F	SCREW-TAPTITE	BH,+,B,M3,L6,ZPC(YEL),SWRCH18A	SNA
6003-000117	SH/PCB+IN/PCB	SCREW-TAPTITE	BH,+,B,M3,L6,ZPC(YEL),SWRCH18A	SNA
6003-000117	SH/PCB+M/PCB	SCREW-TAPTITE	BH,+,B,M3,L6,ZPC(YEL),SWRCH18A	SNA

BN02-00010A	CIS	TAPE ETC	MINERVA,AL-TAPE,0.07MM,60MM,80MM,SILVER,DK-100-60-80	SNA
BN59-00289A	CIS	BOARD-INPUT ASS'Y	MB15U0,INPUT ASS'Y	SNA
BN63-00440A	CIS	FELT-SPACER	MB15KO,FELT,TO.35,10,71.5,BLK	SNA
BN63-00440B	CIS	FELT-SPACER	MB15KO,FELT,TO.35,10,187,BLK	SNA
BN63-00495A	CIS	GASKET	MINERVA,CONDUCTIVE FABRIC,0.13MM,80MM,80MM,GRAY,DK-K102-80-80,CONDUCTIVE TAPE	SNA
BN90-00256A	CIS	ASSY SHIELD-PCB	RB15,-,SECC TO.5,-,-,-,-	SNA
BN63-00177A	CIS	SHIELD-PCB	RB15,SECC,TO.5,-,-,-,-	SNA
BN71-00022A	CIS	EARTH PLATE	RB15AS,SUS,TO.15	SNA
BN91-00567Q	-	ASSY LCD	ES15/NK15,S7	SNA
BN07-00117A	CIS	LCD	LTM150XH-L06,CZB,6BIT_ FRC,331.6*254.76*12.5,16.19M,-,0.297*0.297,-,-,AMLCD/1 LV	
BN92-00436A	-	ASSY BOX	MB15NO	SNA
BH68-00329A	CIS	LABEL BAR CODE	ALL,MPRII,DOM,EXPORT,ART-PAPER 90G,-,-,-,-,WHT,-,-	SNA
BH75-10529A	CIS	UNIT-HANDLE PACKING	LXA410TLMU,PE,-,WHITE,-	SNA
BN72-60001A	CIS	LEVER TOP	LSD210TL,PE-LD,WHITE,TFT_LCD	SNA
BN72-60002A	CIS	LEVER BOTTOM	LSD210TL,PE-LD,WHITE,TFT-LCD	SNA
BN69-00341B	CIS	BOX	LYM1525,ADC,CB-SW4,YEL,A-1,L523*W415*H90	SNA
BN92-00437A	-	ASSY LABEL	MB15NO	SNA
BN68-00267A	CIS	LABEL RATING	MB15U0,ADC,PE,TO.05,65,79,PE NATURE	SNA
BN92-00439A	-	ASSY P/MATERIAL	MB15NO	SNA
0203-001100	CIS	TAPE-OPP MASKING	OPP/W75/CLR,TO.05,W75,L800000,CLR	SNA
BH69-00256C	CIS	PAD-PACKING-EDGE	MV940,B400,W200,L2030,-,-,YEL,-,-	SNA
BH69-00260A	CIS	BAG AIR	DP17L,PE,0.2,1800,1000,NATURAL,-	SNA
BH69-30002C	CIS	BAG-PE	LDPE,TO.05,W2400,NO_PRINT	SNA
BH69-30348C	CIS	BAG-PE	HDPE,TO.02,W350*L430,Y,-,CGB51	SNA
BH69-30355E	CIS	BAG-PE/N	NK15,PE FOAM,0.5,650,650,NTR	SNA
BH69-30360A	CIS	BAG-AIR	HDPE,TO.2,W1000*L1800,N,-,ALL	SNA
BH69-40380A	CIS	PACKING-PAD	DW-2,500X2200X200,-,CGK5527	SNA
BN69-00274A	CIS	CUSHION	RB15,EPS,-,-,-,-,M50	SNA
BN69-00293F	CIS	PALLET-PACKING	MB15,STEEL,1290,1080,100	SNA
BN92-00578Z	-	ASSY ACCESSORY	LTM1525X/XAA,SEA,UNITED STATES	SNA
BN59-00224B	CIS	REMOCON	,TM71,NIKE,42,GR20,NTSC,EX	
BN96-00145Z	CIS	ASSY ACCESSORY	LTM1525X/XAA,SEA,UNITED STATES	
0203-000214	CIS	TAPE-OPP MASKING	OPP/W50/CLR,TO.05,W50,L400000,	SNA
4301-000121	CIS	BATTERY-MN	1.5V,-,AAA,10.5x44.5m,HOLDER	SNA
BH39-10339X	CIS	CBF POWER CORD	DET,SVT,125V/7A,BLK,1830,WALL(ST),MSP-33,MSC-30	
BH39-40355W	CIS	CBF-HARNESS	-,2000MM,IVORY,-,-,-	
BH69-30348D	CIS	BAG-PE	LDPE,TO.05,W240*L356,Y,-,CMG73	SNA
BN39-00043A	CIS	CBF SIGNAL	DETACHABLE,-,15P/15P,-,-,-	
BN96-00159A	CIS	ASSY ACCESSORY	LTM1525X/XAA,SEA,UNITED STATES	
0203-000214	CIS	TAPE-OPP MASKING	OPP/W50/CLR,TO.05,W50,L400000,	SNA
AA68-00371C	CIS	CARD WARRANTY-01	,SEA,W/P100(G),1 YEAR	SNA
BH68-00261P	CIS	MANUAL-00	SEAREGISTRATION CARD,SEA,E,USA,MOJO120G,173,234	SNA
BH69-30348D	CIS	BAG-PE	LDPE,TO.05,W240*L356,Y,-,CMG73	SNA
BN68-00281A	CIS	MANUAL USERS	LTM1525,SAMSUNG,E/F/S/P,ADC,MOJO100G	

8 Block Diagram

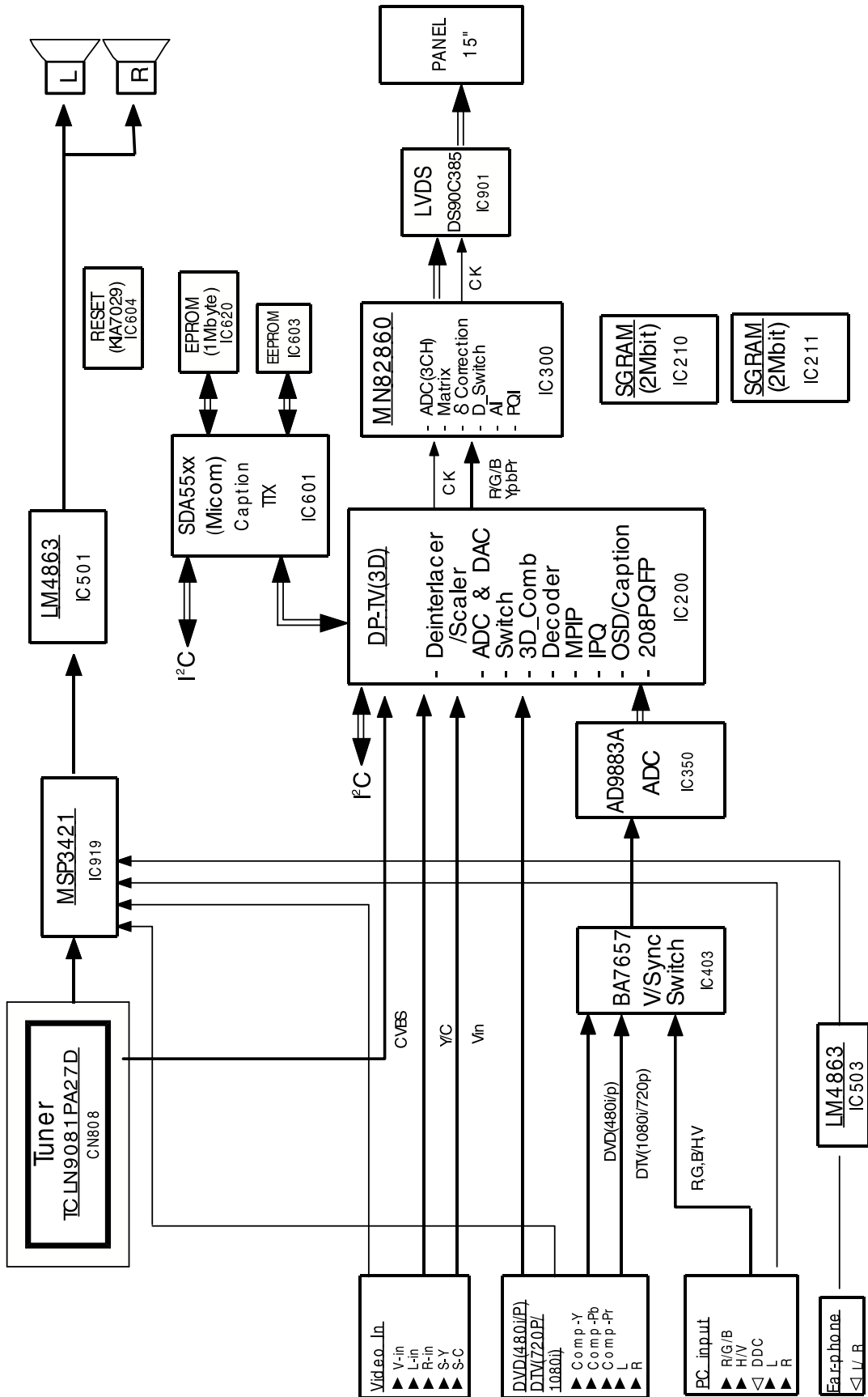

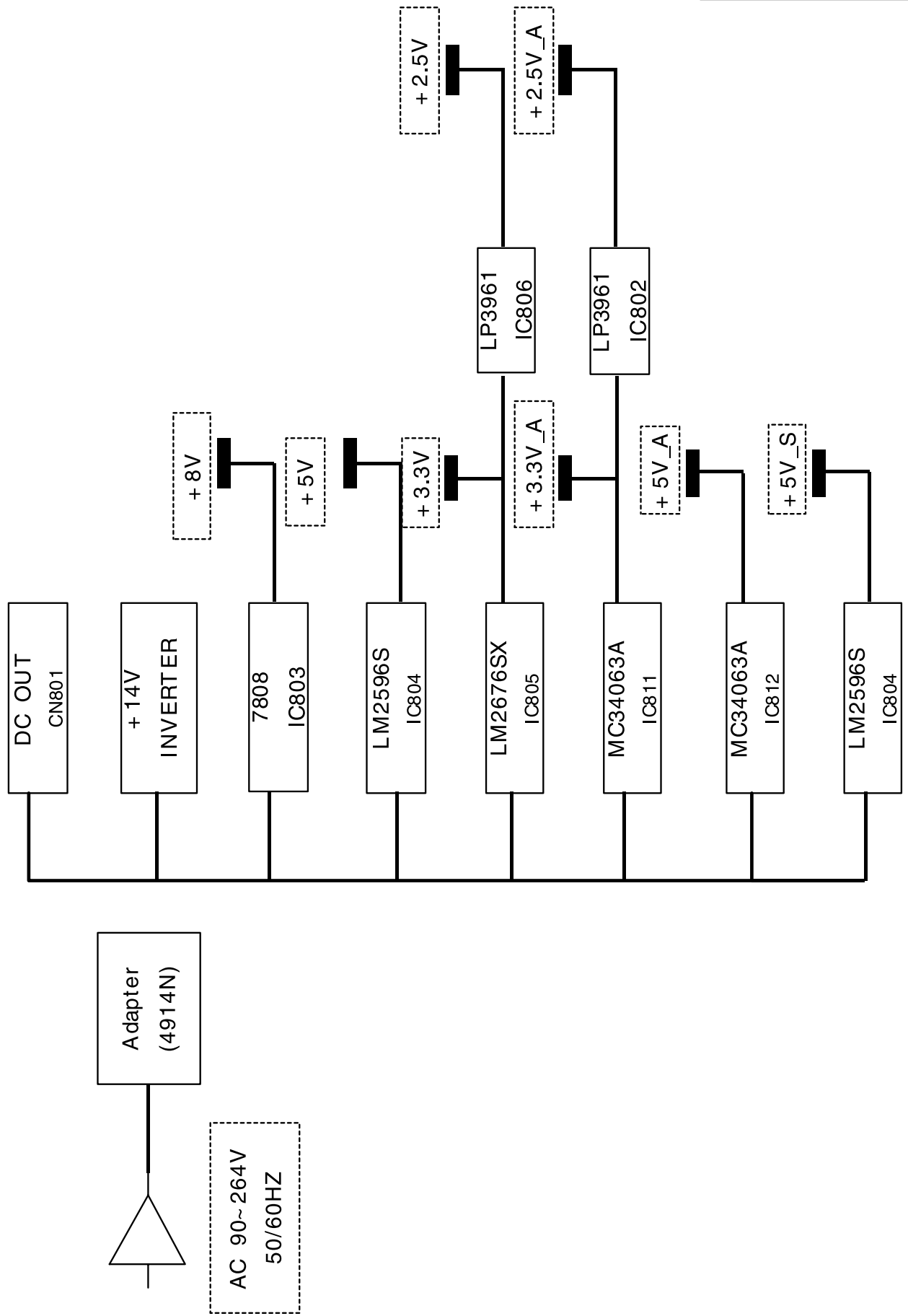

9 Wiring Diagram

9-1 Main Diagram

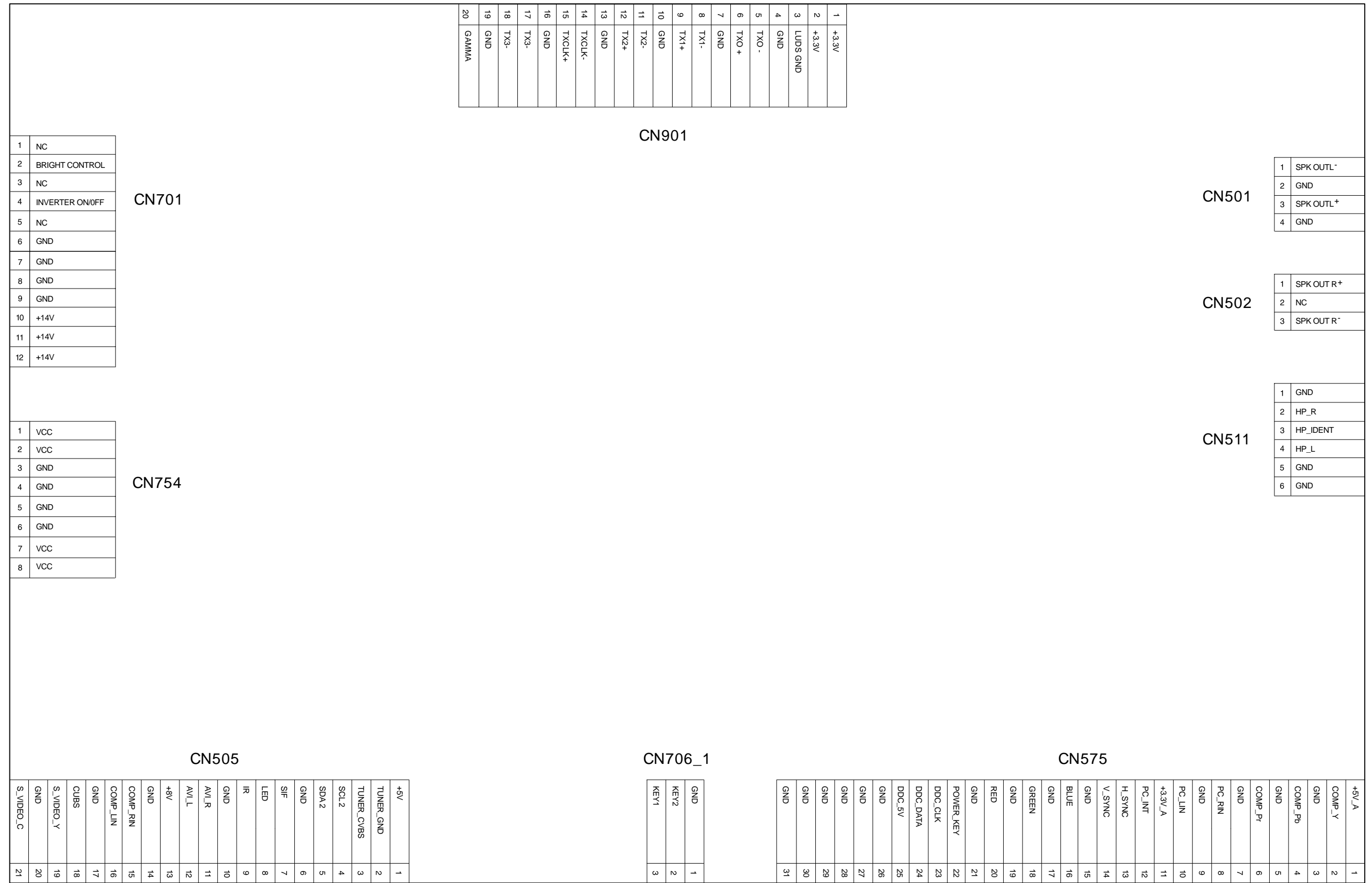

9-2 Input Diagram

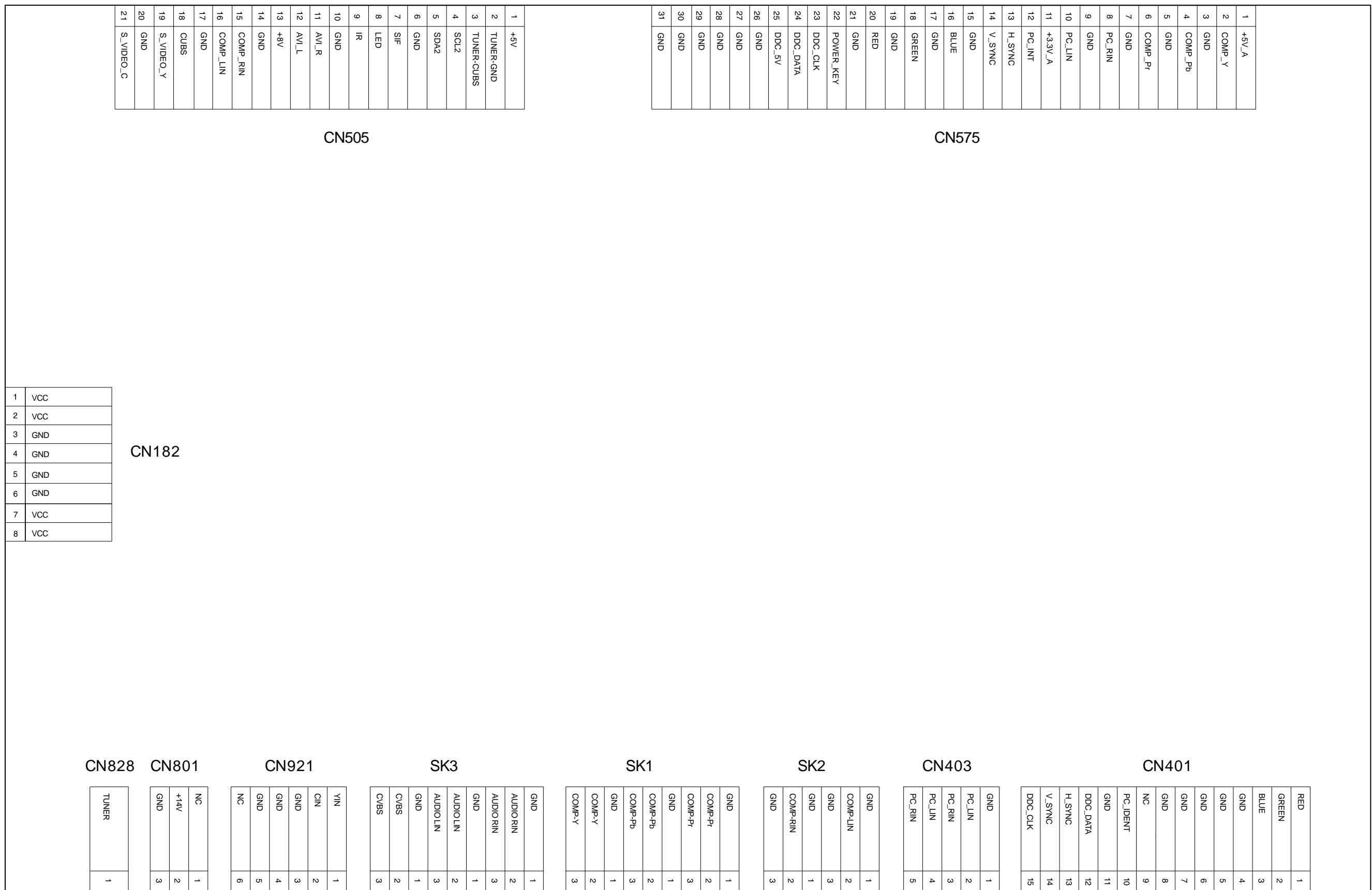

10 Schematic Diagrams

10-1 CPU Block & Signal Processing Part Schematic Diagram

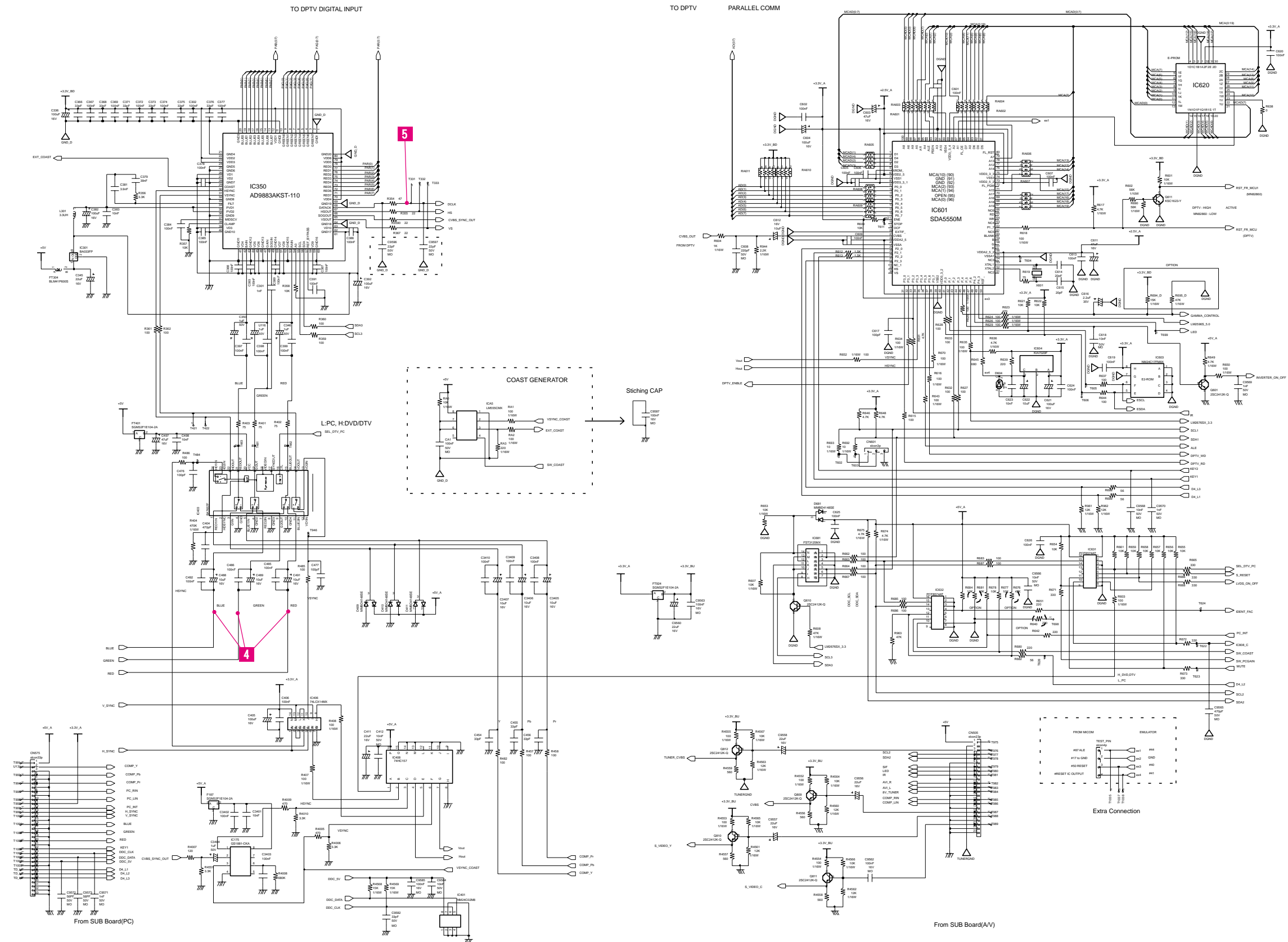

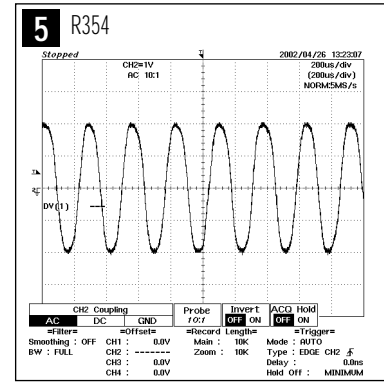
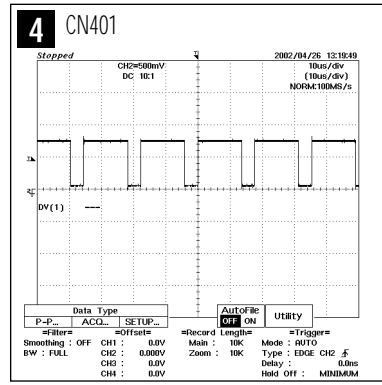

10-2 DPTV & 82860 Part Schematic Diagram

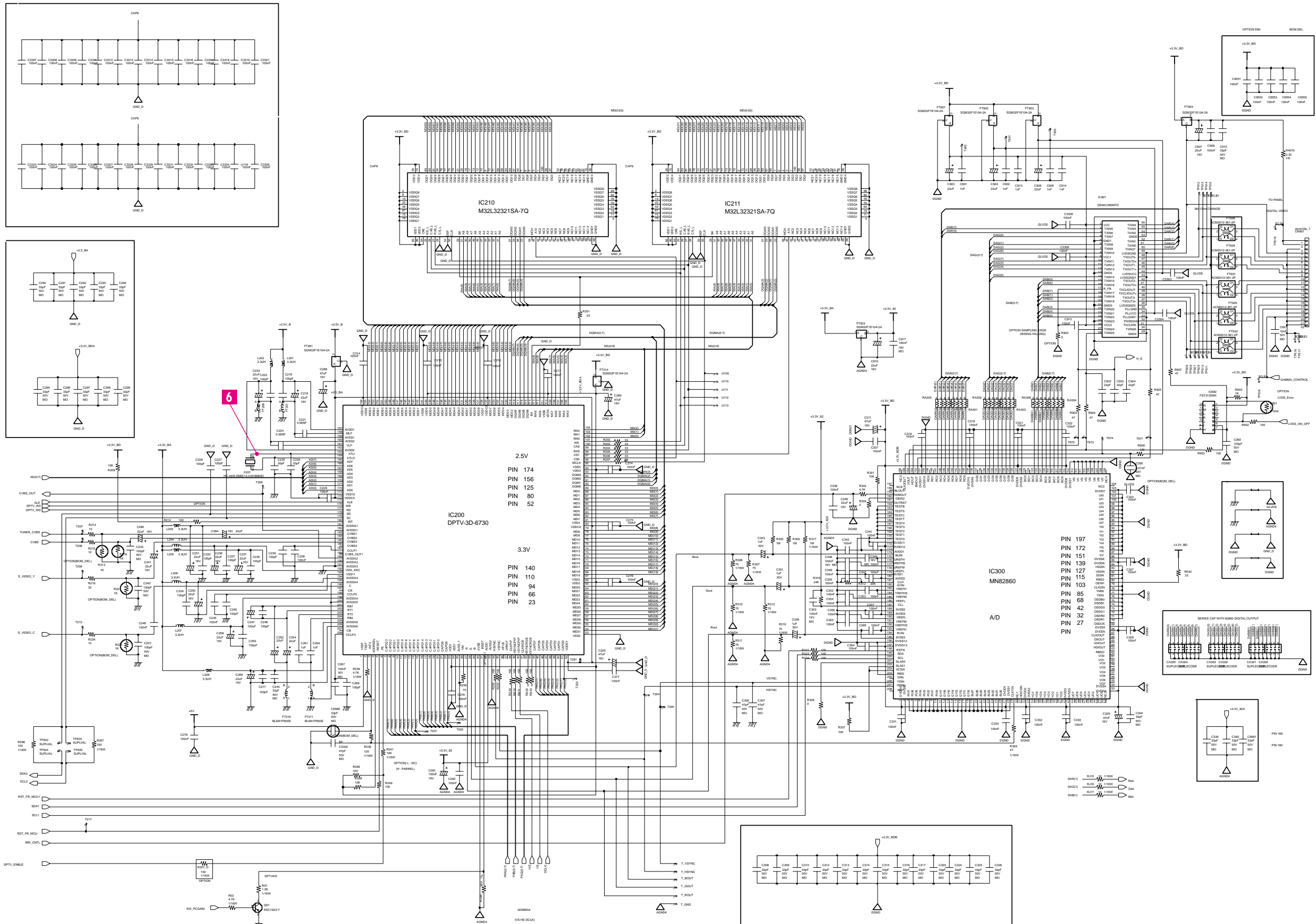

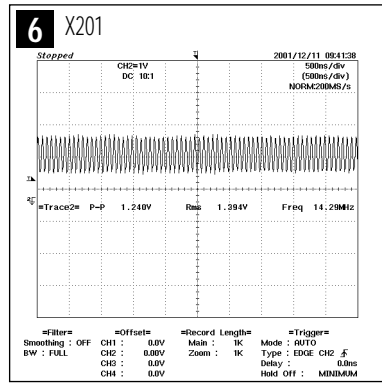

10-3 DC Power Input Part Schematic Diagram

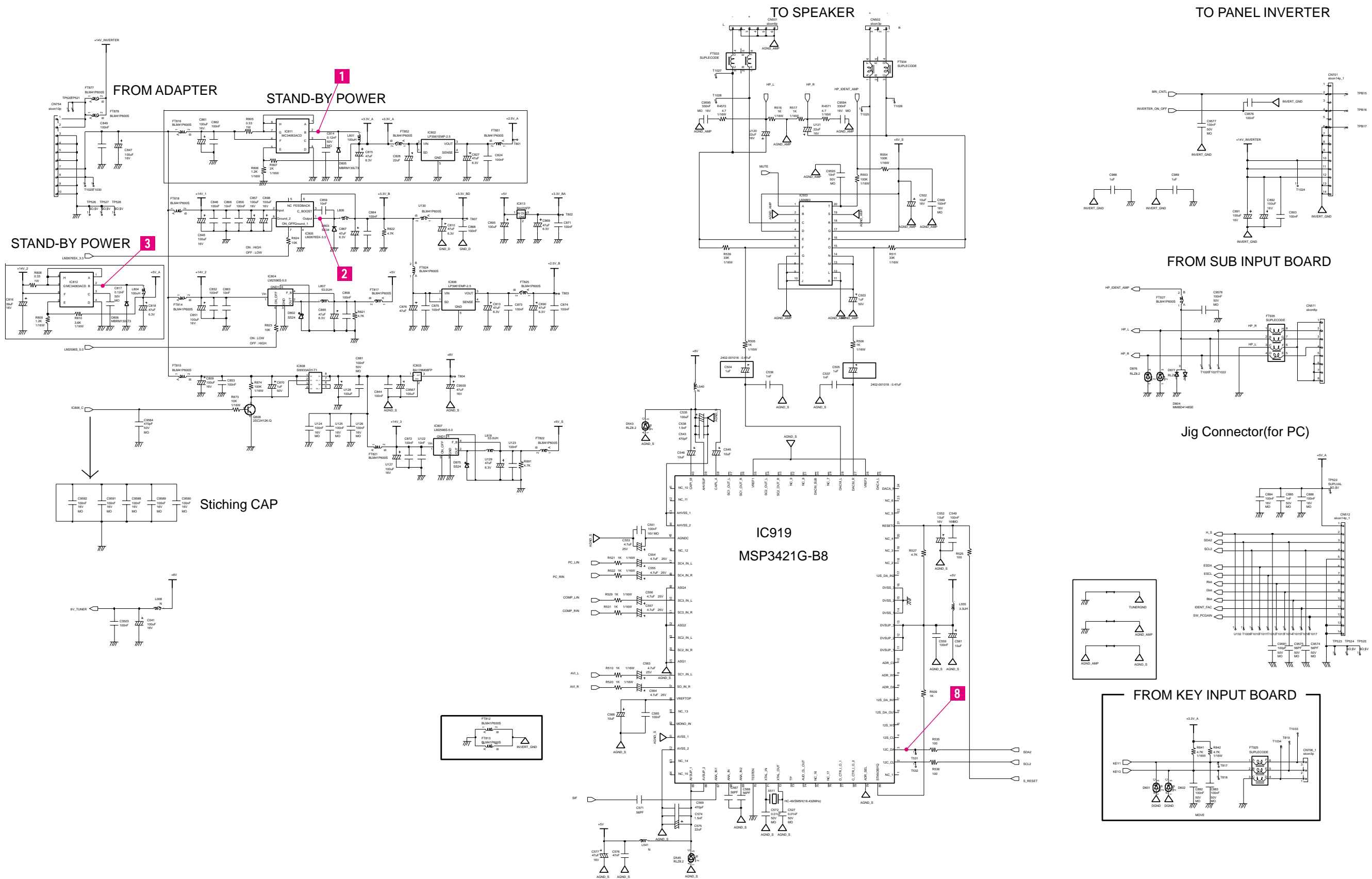

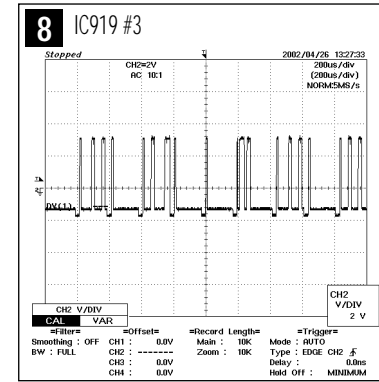
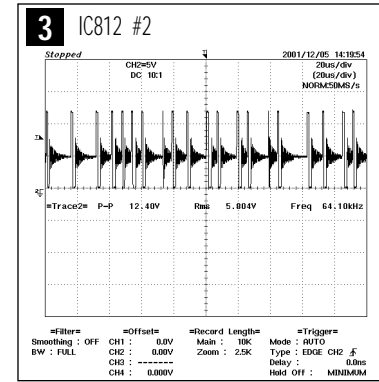
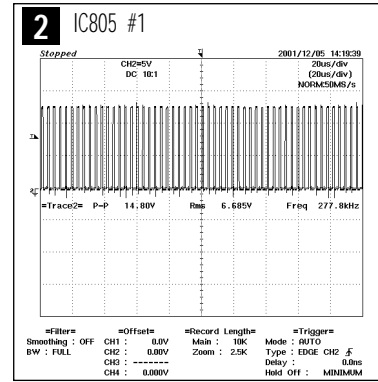
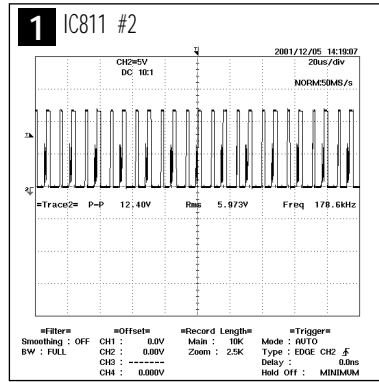

10-4 Input_SUB Part Schematic Diagram

D4 Terminal
(Y / Pb / Pr)

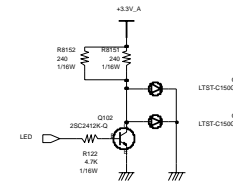
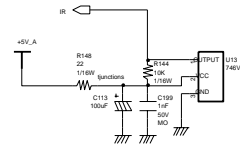
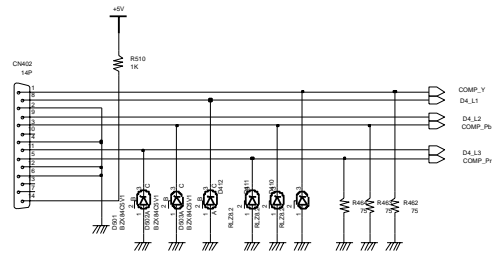

LEFT SIDE

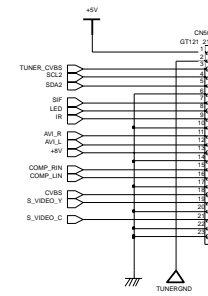

COMP Audio

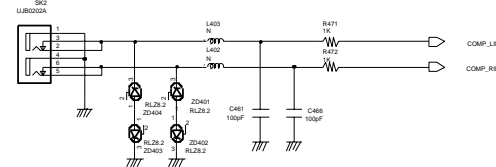

PC Audio

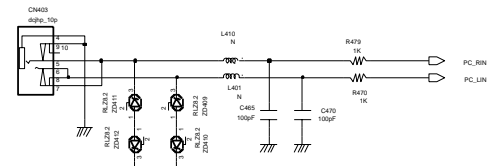

CVBS Input

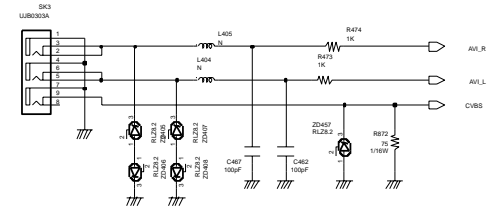

S_Video Input
(Y / C)

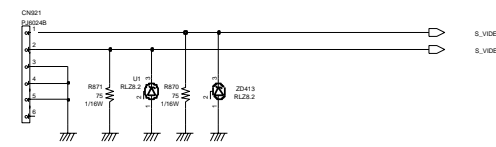

R/G/B Input

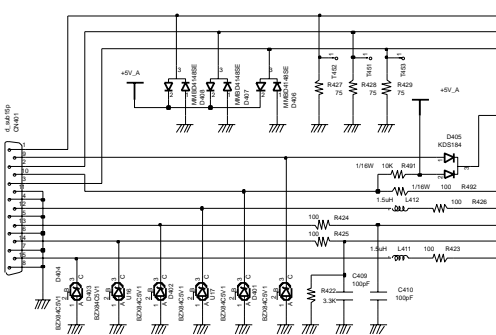

FROM ADAPTER

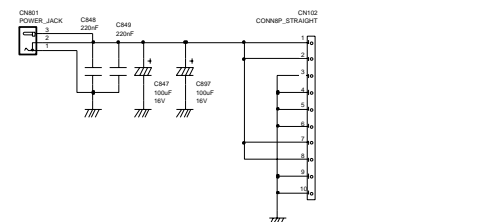

RF Input

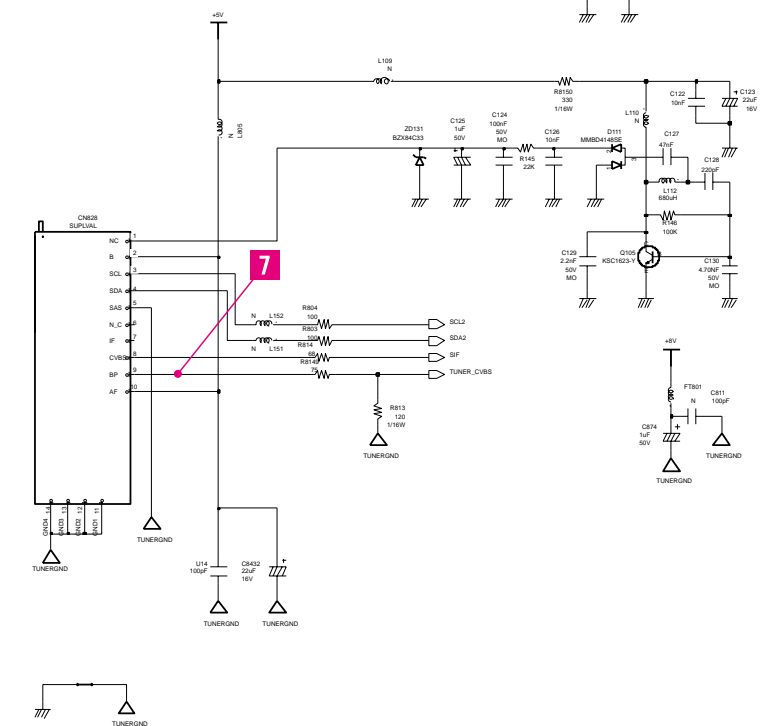

RIGHT SIDE

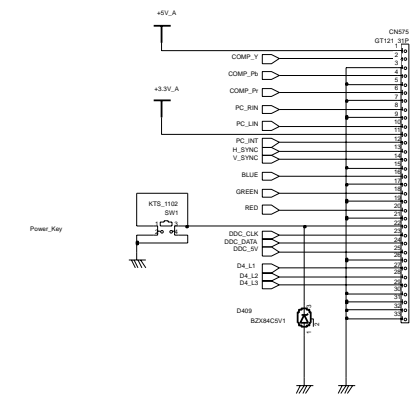

Option

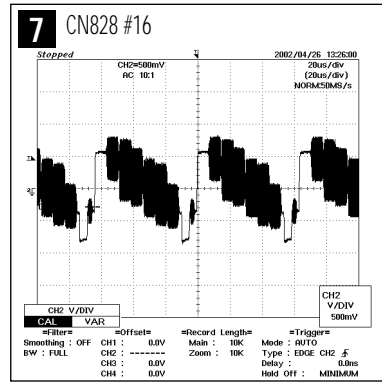



Samsung Electronics Co.,Ltd.

416, Maetan-3Dong, Paldal-Gu, Suwon City, Kyungki-Do, Korea.

Printed in Korea

P/N : BN82-00070A-00

<http://www.samsungmonitor.com> (SyncMaster Worldwide)

<http://www.samsung-monitor.com> (SyncMaster USA)

<http://www.sec.co.kr/monitor> (Korea)